



## **CaterSense – 03 & ATSC-02-xx**

***GAS SUPPLY INTER-LOCK  
STATION with INBUILT  
FAN SPEED CONTROL***

**INSTALLATION and COMMISSIONING  
INSTRUCTIONS**

## Product Overview

The CaterSense system is based on a range of products and ancillary equipment designed to meet the ever changing requirements of the catering industry and associated regulations.

The system comes in four basic modes. You have selected

**CaterSense -03 +** Gas supply controller  
**ATSC-02-xx** with multi-function solutions and inbuilt speed control

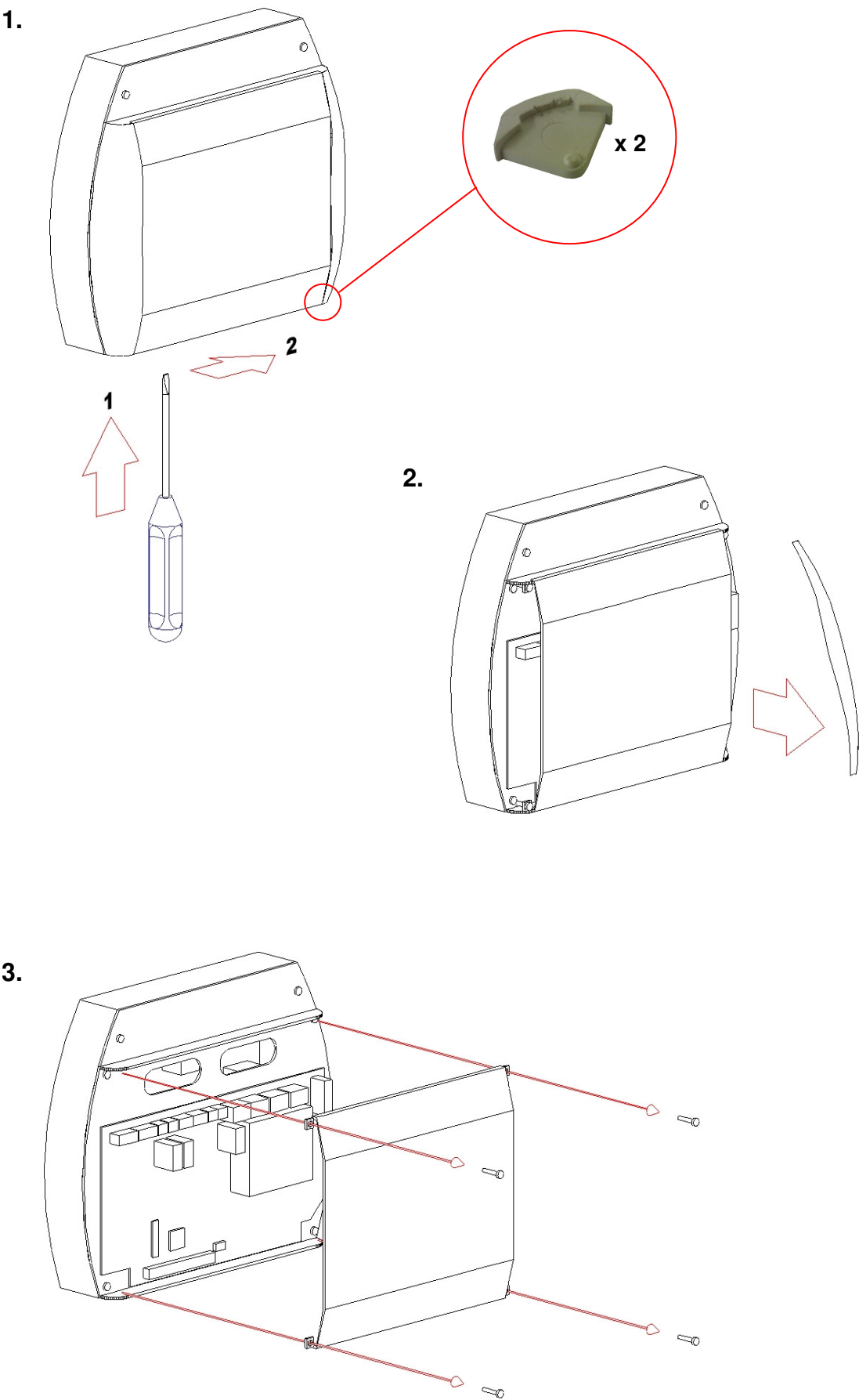
## Contents

- 1.0 General Info
  - 1.01 Opening the unit
  - 1.02 Fixing details
  - 1.03 Cable entry
  - 1.04 Electrical connections
  - 1.05 System mode and set-up (locations)
  - 1.06 Wiring details
- 2.0 Set-up and commissioning
  - 2.01 Initial Set-up
  - 2.02 Mode Set-up
  - 2.03 Functional Operation
  - 2.04 System Checking
  - 2.05 Troubleshooting

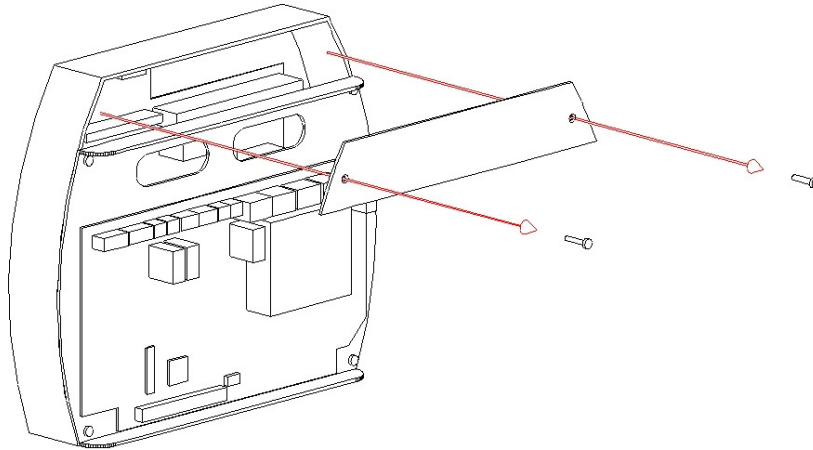
### 1.01 Opening the unit

The CaterSense unit is made up of the following component parts. Please ensure that all components are present before proceeding.

Product code	Quantity	Description
CS-03-PCB-B1	1	CaterSense-03 enclosure base including main PCB
CS-03-F1	1	CaterSense-03 enclosure facia including PCB
CS-CABLE	1	200mm ribbon cable
CS-ASC-LOOM1	1	Pre-made cable loom with 8 way plug (power)
CS-ASC-LOOM2	1	Pre-made cable loom with 10 way plug (control)
CS-SP-01	1	CaterSense enclosure side panel (left)
CS-SP-02	1	CaterSense enclosure side panel (right)
CS-SP-03	2	CaterSense enclosure side panel restraining clip
ATSC-02-08	1	Twin fan speed controller in backing box
ATSC-CP-02	1	Small cover plate for ATSC-02-xx
SCR-02	2	Cover plate fixing screw (M4 x 12)
SCR-03	4	CaterSense facia fixing screw (No 8 x 3/4")
SCR-04	4	CaterSense to ATSC fixing screw (M4 x 16)



4.



5.

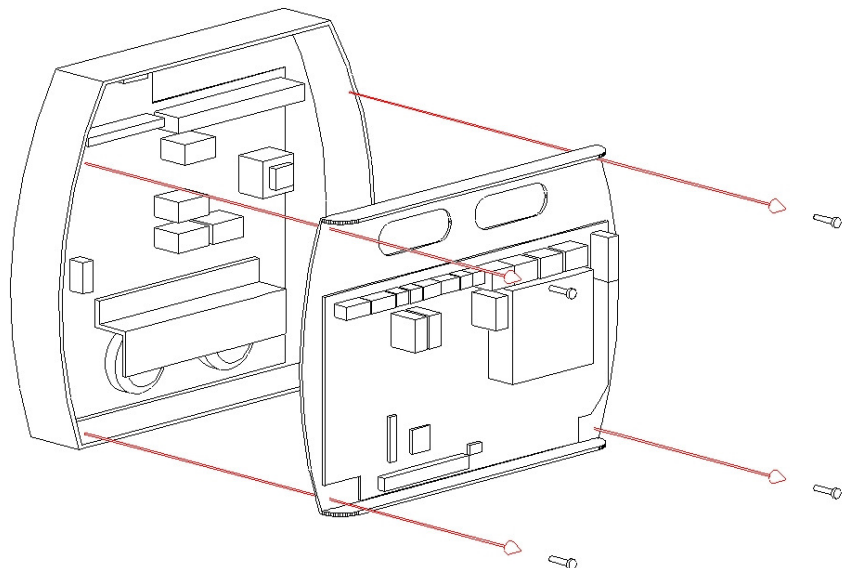


Diagram 1: Opening the unit

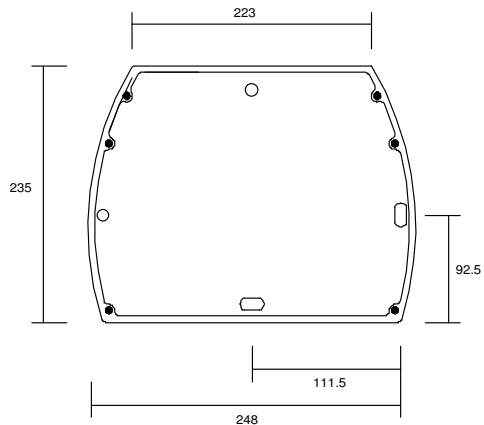
- 1) To open the enclosure, first remove the snap-in clips at the bottom of the two side panels: using a flat bladed screwdriver push the clip from below away from each side panel.
- 2) Press the release pad on each side at the bottom of the enclosure and lift off each side panel in turn by first pulling the bottom towards you. This will reveal the four fascia plate fixing screws.
- 3) Unscrew these four screws and lift the fascia plate from the back box (3), ensuring that the ribbon cable between the two PCBs has been unplugged at the main PCB end.
- 4) Remove the top plate by unscrewing the two screws.
- 5) Unplug the two cable looms from the ATSC PCB, and remove the four fixing screws in the corners of the CaterSense. This will allow you to remove the CaterSense controller completely for ease of installation and wiring.

Place the screws, snap-in clips, controller, side panels and fascia plate in a safe place until the back box has been fixed, wired and is ready for reassembly and set-up.

## 1.02 Fixing details

The CaterSense unit has four (4) mounting holes which can be used (see *Diagram 2*)

*Note: Ensure that the enclosure is mounted on a clean and level surface away from the direct cooking area or sinks and other wet areas.*



*Diagram 2: Fixing details*

## 1.03 Cable entry

The CaterSense & ATSC has two main areas for cable entry: the top area (223 x 40mm) and the back of the enclosure (130 x 30mm located at the top).

For ease of installation, most of the connections you will need are made in the enclosure for the ATSC. The inter-connections between the ATSC and the CaterSense controller are achieved via two pre-made cable looms.

## 1.04 Electrical connections

The ATSC-02-xx system has two sets of terminals all mounted along the top edge of the main PCB circuit board.

**Terminals 1 to 12, & Motor 3 / Motor 4** are the smaller terminals (1.5 mm<sup>2</sup> cable) and are used for the sensors and inter-locking devices (including motor thermal contacts, screen cable to be used).

**Terminals 23 to 34** are the larger terminals (4 mm<sup>2</sup> cable) and are for the power connections for the fans, gas valve and power supply to the unit.

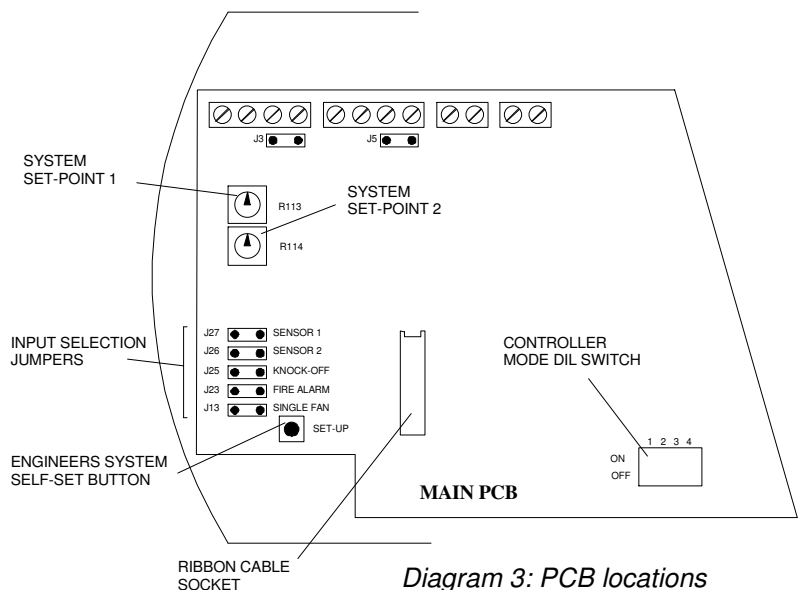
The terminals are of the rising clamp type with protection. See wiring diagram **ATSC-02-08-WD01** for full connection details.

All cabling should be kept to the top of the unit within the designated area. No cables should be placed or laid across the PCBs as they may cause damage.

## 1.05 System mode and set-up

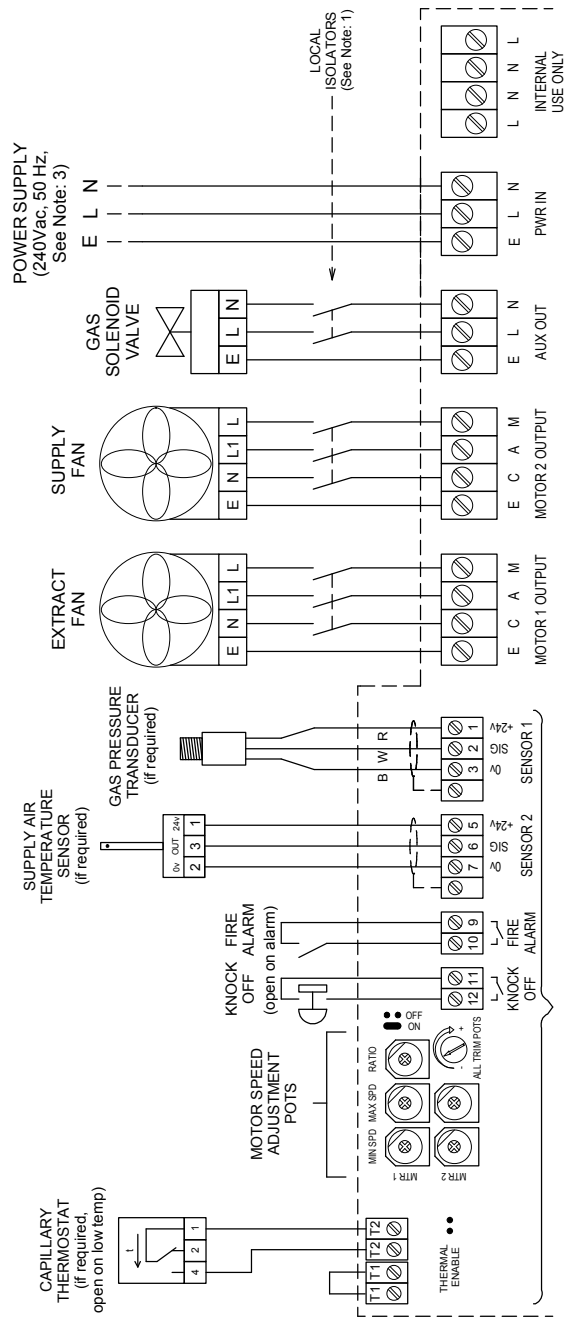
The CaterSense unit has a number of intelligent control solutions in one controller. Each of the solution types has a “Mode Code” which is set via a DIL switch mounted on the main PCB circuit board. The CaterSense also has a unique “Self-set” system commissioning tool which makes for easy system commissioning.

These devices are located on the main PCB as detailed in *Diagram 3*.

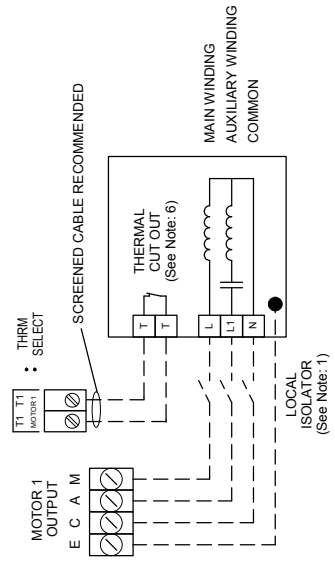


*Diagram 3: PCB locations*

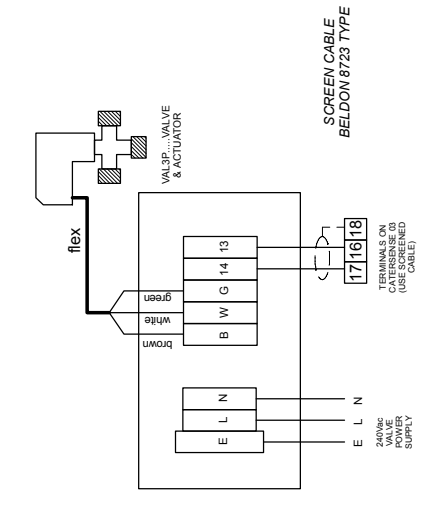
**CONNECTION DETAILS**



**TYPICAL WIRING ARRANGEMENT FOR A SINGLE PHASE MOTOR (3 WIRE - See Note: 5)**



**3-PORT VALVE ADDITIONAL CONNECTION BOX**



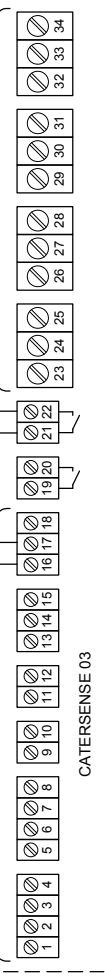
SCREENED CABLE RECOMMENDED

PRE-WIRED CONNECTIONS (LOW VOLTAGE)

HEATER DEMAND (0-10Vdc)

HEAT PUMP/ SOLER ENABLE (VOLTAGE VARY, MAX 24Vdc)

PRE-WIRED CONNECTIONS (240Vac)



**NOTES:**

- 1) LOCAL ISOLATION MUST BE PROVIDED IN ACCORDANCE WITH THE CURRENT EDITION OF THE IEE REGULATIONS.
- 2) CHECK MANUFACTURER'S WIRING DETAILS FOR CORRECT CONNECTIONS AND SET-UP REQUIREMENTS.
- 3) ENSURE THAT THE POWER SUPPLY IS CORRECTLY RATED TO THE SIZE OF BOTH FAN MOTORS AND GAS VALVE.
- 4) ENSURE THAT THE SWITCHED POWER IS CORRECTLY FUSED TO THE LOADING OF THE POWER MONITOR AND / OR GAS VALVE.
- 5) FOR MAXIMUM OPERATING EFFICIENCY, MINIMUM NOISE, AND REDUCED RUNNING CURRENTS, THREE WIRE CONTROL OF SINGLE PHASE MOTORS IS STRONGLY RECOMMENDED BY TRENT PRODUCTS AND MOST MOTOR MANUFACTURERS.
- 6) MOTOR THERMAL CUT-OUTS (IF PRESENT) SHOULD BE EITHER CONNECTED IN SERIES WITH POWER WIRING, OR CONNECTED TO T1 OR T2 TERMINALS ON SPEED CONTROL PCB.

**TRENT PRODUCTS**

Tel: 01782 - 844688 Fax: 01782 - 844772

**TWIN SPEED CONTROLLER WIRING & CONNECTION DIAGRAM**

**DATE:**

05/06/08

**DRAWING No:**

ATSC-08-02-WD01

**DRAWN BY**

RR

## 2.0 Set-up and Commissioning

The set-up and commissioning of your CaterSense system is in two parts, **Initial** and **Mode**.






### 2.01 Initial Set-up

Once all of the wiring has been completed and tested and the system is ready to be set-up and commissioned, the following sequence **MUST** be followed to ensure the CaterSense and system operate correctly.


#### a) DIL Mode switch

Ensure the correct system code has been selected on the DIL switch.

**IMPORTANT:** Ensure power supply is switched OFF before adjusting DIL mode switch

Mode Code	DIL position	Fan speed adjustment		Gas pressure proving	Heater battery control	
		Manual	System Demand		LPHW only	Electric / Gas fired
03-02		✓	✗	✗	✓	✗
03-03		✓	✗	✓	✓	✗
03-04		✗	✓	✗	✓	✗
03-05		✗	✓	✓	✓	✗
03-06		✓	✗	✓	✗	✓

#### b) Input Jumpers / Sensor Links

ON =  OFF = 

**IMPORTANT:** Ensure power supply is switched OFF before adjusting input jumpers or sensor links.

**J3 and J5** (located beneath terminals 4 and 8) - If using remote current monitoring CS-RCT-xx for channel 1 or 2, ensure that the appropriate jumper is OFF. Otherwise, ensure that the jumper is ON. (*Channel 1 = J3, Channel 2 = J5*)

**J27** (SENSOR1) - If using gas pressure proving OR remote current monitoring for channel 1, ensure that J27 is OFF. Otherwise, ensure J27 is ON.

**J26** (SENSOR2) - If using remote current monitoring for channel 2, ensure that J26 is OFF. Otherwise, ensure J26 is ON.

**J25** (KNOCKOFF) - If using a remote knockoff circuit in terminals 11 and 12, ensure that J25 is OFF. Otherwise, ensure J25 is ON.

**J23** (FIRE ALARM) - If using a fire alarm circuit in terminals 9 and 10 OR a fan hold-off thermostat OR thermal cut-outs from fans connected to terminals Motor 3 or Motor 4, ensure that J23 is OFF. Otherwise, ensure J23 is ON.

If using Motor 3 and/or Motor 4, the **THRM SELECT** jumper on the ATSC-02-xx PCB must be OFF, and a link fitted between the unused terminals. If **THRM SELECT** is ON, any inputs connected to Motor 3 and Motor 4 terminals are ignored.

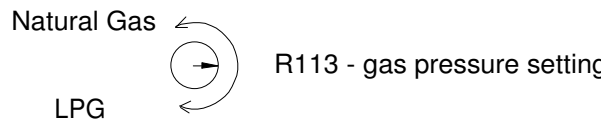
**J13** (SINGLE) - If only using one fan, ensure J13 is ON. Otherwise, ensure J13 is OFF.

## c) Inter-lock circuits

Ensure that the fire alarm and knock-off switches (if fitted) are all in the operational position.

## d) Gas pressure range

The type of gas used in your system is selected via the pot R113 on the main CaterSense PCB. This should be turned fully clockwise for LPG systems, and fully anti-clockwise for natural gas.



With both systems, a pipework integrity test is carried out whenever the system is initialised with the "start" pad. This opens the gas solenoid valve for 10 seconds, and then closes the valve for 30 seconds and monitors the pressure. If this pressure drops by 10% or more at all during this 30 seconds, the system will not start.

When all of the above stages have been completed, re-assemble the CaterSense unit by reversing the sequence described above in section 1.01.

**NOTE:** Ensure the ribbon cable is plugged in correctly with the key pin (red stripe) at the **top** on the main PCB, and at the **bottom** on the facia (see Diagram 4).

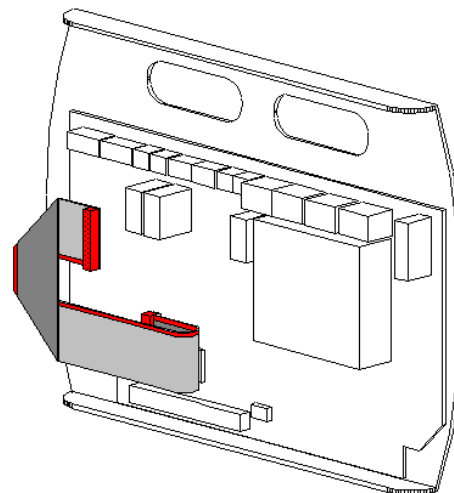


Diagram 4: Ribbon cable

## 2.02 Mode Set-up – CaterSense 3

Once the above has been carried out, the system is ready to be powered up.

Within the step-by-step sequence of set-up instructions the CaterSense unit will give you feedback on the system via audible "beeps" and coloured LEDs.









### Set-up sequence:

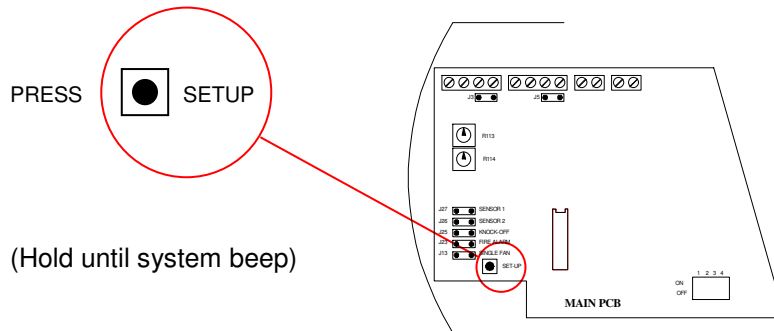
- 1) **Activate "SETUP" mode on controller**
- 2) **Gas pressure proving set-up (if required)**
- 3) **Fan power monitoring set-up**
- 4) **Heater battery set-up (if required)**

The sequence detailed above **MUST** be followed to enable the CaterSense unit to program its parameters. During the balancing phase of the set-up (stage 3), ensure that the system is allowed to settle and become stable before moving on to the next stage. **DO NOT RUSH.**











## 1) Activate "SETUP" mode on controller

- |   |                  |   |           |
|---|------------------|---|-----------|
|  | POWER ON         |  | GAS VALVE |
|  | SYSTEM CONDITION |  | FAN 1     |
|  | REMOTE KNOCK OFF |  | FAN 2     |
|  | FIRE ALARM       |   |           |
|  | MIN AIR FLOW     |   |           |






## 2) Gas pressure proving set-up (go directly to stage 3 if not required)



- 2)
- |   |                  |   |           |
|---|------------------|---|-----------|
|  | POWER ON         |  | GAS VALVE |
|  | SYSTEM CONDITION |  | FAN 1     |
|  | REMOTE KNOCK OFF |  | FAN 2     |
|  | FIRE ALARM       |   |           |
|  | MIN AIR FLOW     |   |           |


PRESS   GAS VALVE



The gas valve will open to allow for system checking. If no further action is taken, the gas valve will close automatically after 5 minutes. Otherwise, press the START pad to start the gas pressure test.

PRESS   GAS VALVE

 10 sec

  GAS VALVE

 30 sec

  SYSTEM CONDITION

PRESS  SETUP

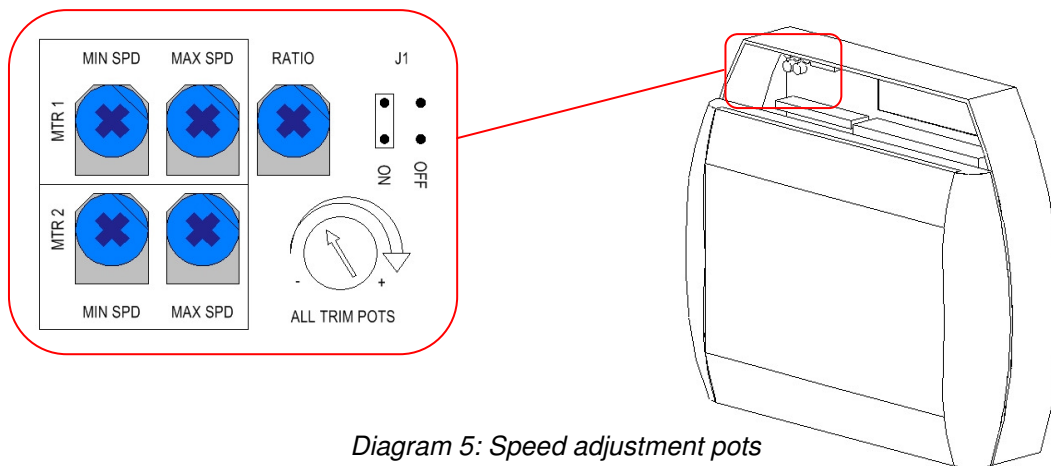
**3) Fan power monitoring set-up**

- POWER ON
- GAS VALVE
- ☀ SYSTEM CONDITION
- REMOTE KNOCK OFF
- FAN 1
- FIRE ALARM
- FAN 2
- MIN AIR FLOW



The fans will start at full speed. Using the and pads in conjunction with the min and max pots on the ATSC-02-xx PCB ensure that the system has been correctly balanced, and you have correctly set the minimum and maximum speeds for each fan.

The ratio pot adjusts the speed of fan 2 relative to fan 1, to allow you to balance the make-up air with the amount of air extracted.



*Diagram 5: Speed adjustment pots*

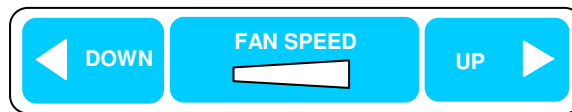
**IMPORTANT:** Ensure that you do not set the minimum speed to a level that will cause the fan to overheat. Trent Products recommend a minimum voltage output to the fans of no less than 140Vac between the "M" and "C" terminals. Consult the fan manufacturer for more details.

PRESS SETUP

- |                                     |                  |                                     |           |
|-------------------------------------|------------------|-------------------------------------|-----------|
| <input type="checkbox"/>            | POWER ON         | <input type="checkbox"/>            | GAS VALVE |
| <input checked="" type="checkbox"/> | SYSTEM CONDITION | <input checked="" type="checkbox"/> | FAN 1     |
| <input type="checkbox"/>            | REMOTE KNOCK OFF | <input checked="" type="checkbox"/> | FAN 2     |
| <input type="checkbox"/>            | FIRE ALARM       |                                     |           |
| <input type="checkbox"/>            | MIN AIR FLOW     |                                     |           |



↓  
2 mins  
↓

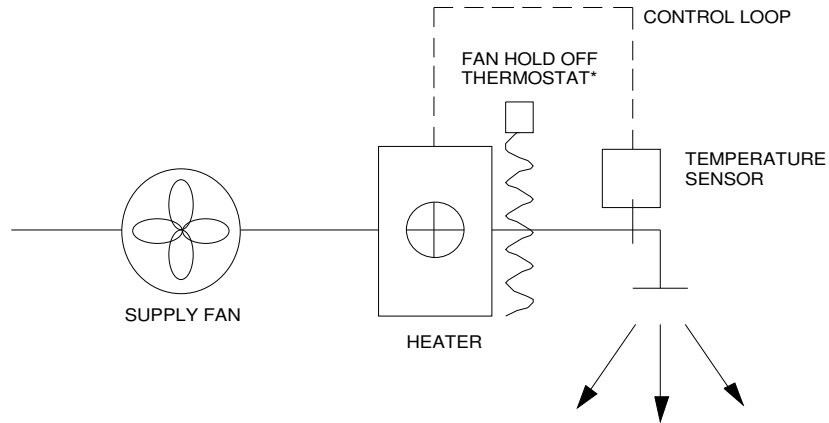


The system will produce a short beep. The CaterSense will slowly reduce the speed of the fans to establish the characteristics of your system. **DO NOT INTERRUPT THIS PROCESS.** After approximately two minutes, the system will have fully recorded the running currents of your fans. If you have an electric or gas fired heater battery connected, the fans will run on for a further 15 minutes. Otherwise, the fans will stop straight away.

- |                          |                  |                          |           |
|--------------------------|------------------|--------------------------|-----------|
| <input type="checkbox"/> | POWER ON         | <input type="checkbox"/> | GAS VALVE |
| <input type="checkbox"/> | SYSTEM CONDITION |                          |           |
| <input type="checkbox"/> | REMOTE KNOCK OFF | <input type="checkbox"/> | FAN 1     |
| <input type="checkbox"/> | FIRE ALARM       | <input type="checkbox"/> | FAN 2     |
| <input type="checkbox"/> | MIN AIR FLOW     |                          |           |

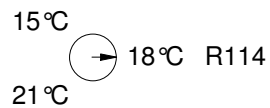
## 4) Tempered supply air control set-up (if required)

A fully-modulating signal will be sent to the heater battery to maintain the temperature of the supply air at the setpoint selected during set-up. To maintain this signal ensure that the CaterSense unit is left switch on at all times.



\* Normally only fitted to LPHW heater batteries

The setpoint for the tempered air control can be adjusted from  $18^{\circ}\text{C} \pm 3^{\circ}\text{C}$  using pot R114 on the main PCB.

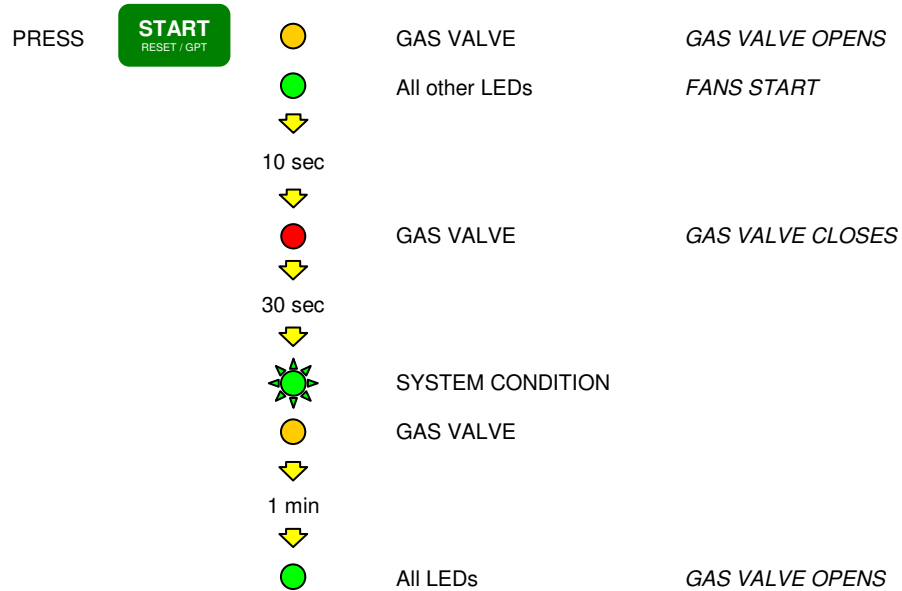


**Note: Please refer to section 2.04 (System Checking) before starting the CaterSense unit to ensure that it has been successfully commissioned.**

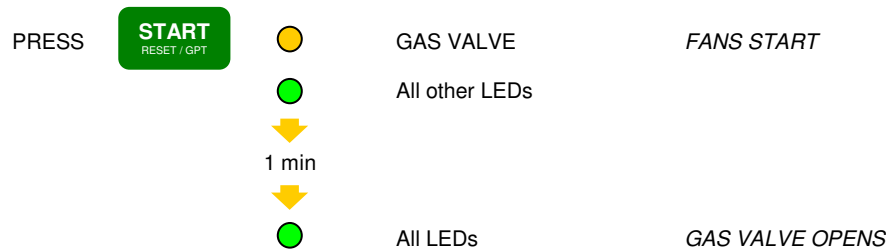
## 2.03 Functional Operation

The operation of the CaterSense unit and system in this Mode is as follows:

### For modes WITH gas pressure proving:



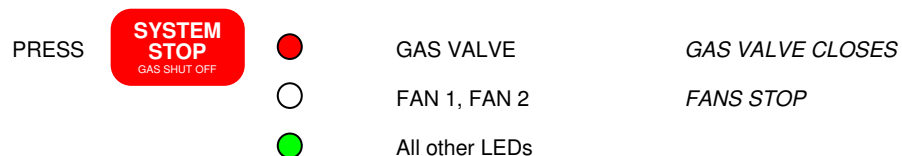
### For modes WITHOUT gas pressure proving:



### For all modes:

The speed of the extract fan can be changed using and .

The supply fan will change speed according to the signal sent to it from CaterSense. This signal is a percentage of the signal to the extract fan, established using the ratio adjustment pot during set-up.

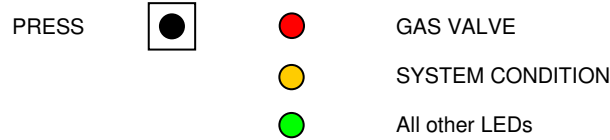


If you have an electric or gas fired heater battery connected, the fans will run on for a further 15 minutes. Otherwise, the fans will stop straight away.

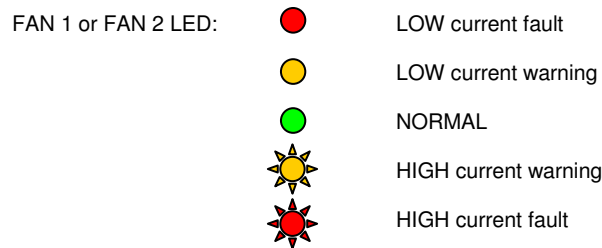
## 2.04 System Checking

As an aid to system commissioning, CaterSense has a diagnostic tool which can be used to quickly check that the stored settings are suitable for correct operation.

To access this tool,

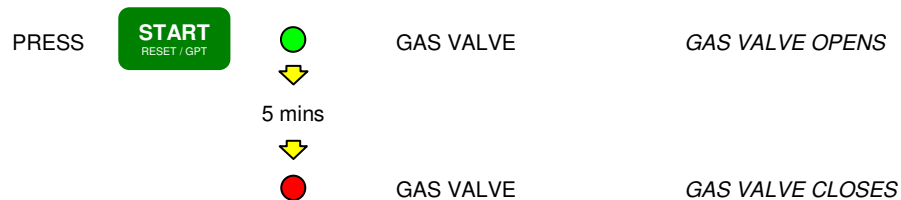


In this mode, the FAN 1 and FAN 2 LEDs will instantly react to the current being drawn by the attached motors. By slowly adjusting the speed control for the motors and observing the LEDs, the parameters can be quickly checked and problems identified.



If the current is at a "fault" level for longer than 30 seconds, a system fault would occur during normal operation. It is normal for current draw to fall outside normal levels for a few seconds whilst changing speeds. Allow fan to settle at each speed. IF IN DOUBT, ASK.

Diagnostic mode also allows the manual opening of the gas valve for testing purposes, for a maximum of 5 minutes.



To leave diagnostic mode, press



## 2.05 CaterSense troubleshooting sheet

### 2.05.1 - SYSTEM STOPPED

- POWER ON
- SYSTEM CONDITION
- REMOTE KNOCK OFF
- FIRE ALARM
- GAS VALVE
- FAN 1
- FAN 2

Cause:- The system has been stopped  
Solution:- Press "Start" key to begin startup sequence

### 2.05.2 - FIRE ALARM

- POWER ON
- SYSTEM CONDITION
- REMOTE KNOCK OFF
- FIRE ALARM
- GAS VALVE
- FAN 1
- FAN 2

Cause:- The link between terminals 9 and 10 has been broken (fire alarm activated). The fan and gas valve outputs will be deactivated. Ensure fire alarm is not activated. Check wiring to fire alarm interface panel. The system must be reset by pressing "STOP" before it can be restarted.

### 2.05.3 - KNOCK OFF BUTTON

- POWER ON
- SYSTEM CONDITION
- REMOTE KNOCK OFF
- FIRE ALARM
- GAS VALVE
- FAN 1
- FAN 2

Cause:- The link between terminals 11 and 12 has been broken (knock off pressed). The gas valve output will be deactivated. Ensure remote knock off button has been released. Check wiring to remote knock-off button. The system must be reset by pressing "STOP" before it can be restarted.

### 2.05.4 - FAN UNDERCURRENT

- POWER ON
- SYSTEM CONDITION
- REMOTE KNOCK OFF
- FIRE ALARM
- GAS VALVE
- FAN 1 or FAN 2

Cause:- The indicated fan is drawing less current than the minimum current established during commissioning.  
Solution:- Ensure fan is working correctly. Check running current with an ammeter. Use the diagnosis mode to establish any problems with set-up. The system must be reset by pressing "STOP" before it can be restarted.

### 2.05.5 - FAN OVERCURRENT

- POWER ON
- SYSTEM CONDITION
- REMOTE KNOCK OFF
- FIRE ALARM
- GAS VALVE
- FAN 1 or FAN 2

Cause:- The indicated fan is drawing more current than the maximum current established during commissioning.  
Solution:- Ensure fan is working correctly. Check running current with an ammeter. Check filters are clean. Use the diagnosis mode to establish any problems with set-up. The system must be reset by pressing "STOP" before it can be restarted.

### 2.05.6 - GAS PRESSURE FAULT 1

- POWER ON
- SYSTEM CONDITION
- REMOTE KNOCK OFF
- FIRE ALARM
- GAS VALVE
- FAN 1
- FAN 2

Cause:- The system has failed its initial gas pressure test.  
Solution:- Ensure all gas appliances are off. Check wiring to gas pressure sensor. Check gas pressure. The system must be reset by pressing "STOP" before it can be restarted.

### 2.05.7 - GAS PRESSURE FAULT 2

- POWER ON
- SYSTEM CONDITION
- REMOTE KNOCK OFF
- FIRE ALARM
- GAS VALVE
- FAN 1
- FAN 2

Cause:- The gas pressure has dropped below 12mbar during normal running.  
Solution:- See above.

### 2.05.8 - MEMORY ERROR

- POWER ON
- SYSTEM CONDITION
- REMOTE KNOCK OFF
- FIRE ALARM
- GAS VALVE
- FAN 1
- FAN 2

Cause:- The system has failed the test of its internal memory (tested at power on).  
Solution:- The system must be recommissioned to store new values into the memory. Please contact a competent person and consult your installation manual.

**If the above does not solve your problem, contact Trent Products.**

\* Only on modes with gas pressure proving

FOR FURTHER TECHNICAL ASSISTANCE, PLEASE CONTACT US BY

Phone: 01782 844688

Fax: 01782 844772

E-mail: [info@trentproducts.com](mailto:info@trentproducts.com)

Web site: [www.trentproducts.com](http://www.trentproducts.com)

- Note:
- i) Ensure that the electrical installation has been installed in accordance with the current edition of the IEE regulations.
  - ii) Ensure that the gas installation has been installed in accordance with the current gas regulations and GAS SAFE guide-lines.
  - iii) Ensure that the ventilation and extract system has been set to the correct air flow design levels in accordance with the current regulations.
  - iv) If in doubt, ask! (Contact us on or by any of the above).
  - v) Ensure that the client has been shown how to operate the system and that they have been handed the user's guide.



This symbol on this product or the package indicates that disposal of this product after its lifecycle could harm the environment.  
DO NOT dispose of this product (or batteries if used) as unsorted municipal waste. It should be disposed by a specialised company for recycling.  
This product should be returned to your distributor or to a local recycling service. Respect the local environment rules.

**TRENT PRODUCTS**  
**Trent House**  
**Dewsbury Road**  
**Fenton**  
**Stoke-on-Trent**  
**Tel: 01782 844688 Fax: 01782 844772**