

CaterSense *the Intelligent answer*



CaterSense -04

***GAS SUPPLY CONTROL with
MULTI FUNCTION SOLUTIONS***

***INSTALLATION and COMMISSIONING
INSTRUCTIONS***

CaterSense the Intelligent answer

Product Overview

The CaterSense system is based on a range of products and ancillary equipment design to meet the ever changing requirements of the catering industry and associated regulations.

The system comes in four basic modes, you have selected

CaterSense -04 intelligent controller *with Multi function solutions*

The controller has a unique “self-set” system which makes for easy system commissioning.

Contents

1.0 General Info

- 1.01 Opening the unit
- 1.02 Fixing details
- 1.03 Cable entry
- 1.04 Electrical connections
- 1.05 System mode and set-up (locations)

2.0 Set-up and commissioning

- 2.01 Initial Set-up
- 2.02 Mode Set-up
- 2.03 System Checking
- 2.04 Troubleshooting

1.0 General Information

1.01 Opening the unit

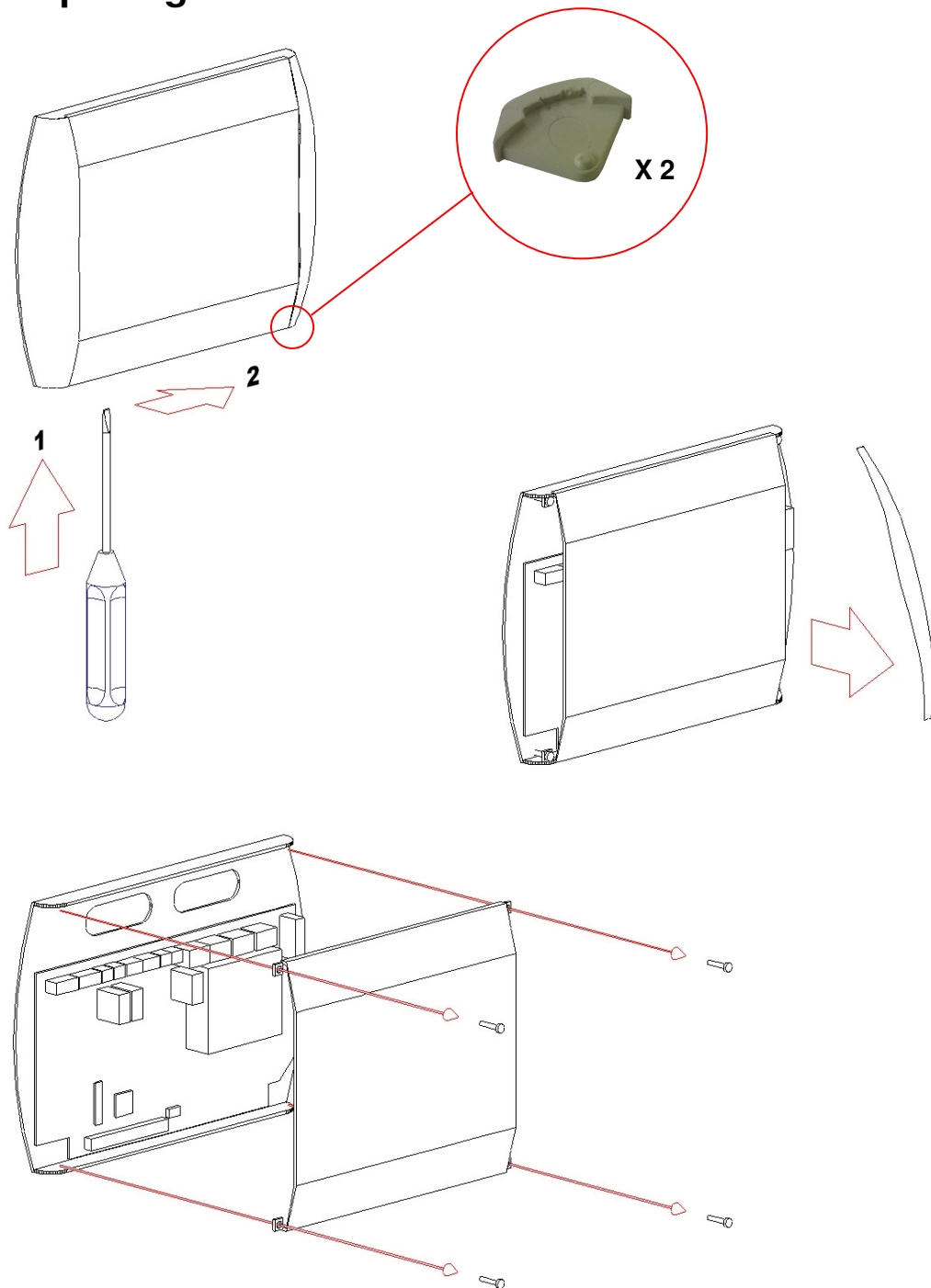

- 1) To open the enclosure, first remove the snap-in clips at the bottom of the two side panels: using a flat bladed screwdriver push the clip from below away from each side panel.
- 2) Press the release pad on each side at the bottom of the enclosure and lift off each side panel in turn by first pulling the bottom towards you. This will reveal the four facia plate fixing screws.

CaterSense the Intelligent answer

- 3) Unscrew these four screws and lift the fascia plate from the back box (3), ensuring that the ribbon cable between the two PCBs has been unplugged at the main PCB end.

Place the screws, snap-in clips, side panels and fascia plate in a safe place until the back box has been fixed, wired and is ready for reassembly and set-up

1.02 Fixing details

The CaterSense unit has six (6) mounting holes which can be used (as shown below)

Note: Ensure that the enclosure is mounted on a clean and level surface away from the direct cooking area or wet surfaces.

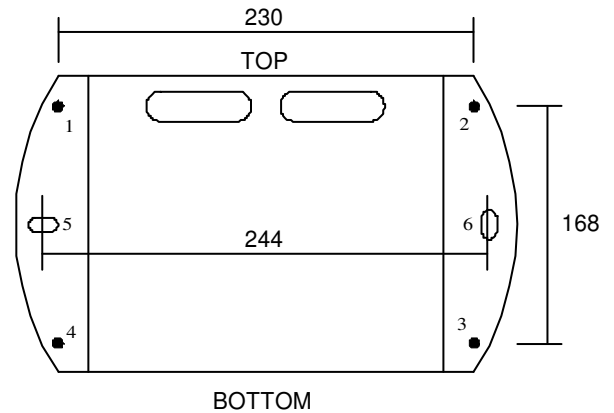

1.03 Cable entry

The CaterSense unit has two knock-out slots in the back of the enclosure (located at the top) to enable back entry. The enclosure has an area 190 x 25 mm which can be drilled for conduit entry on the top edge of the enclosure.

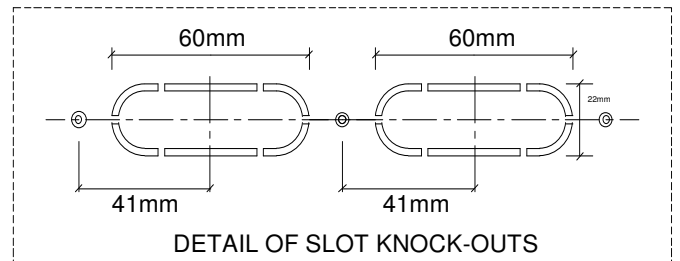

1.04 Electrical connections

The CaterSense system has two sets of terminals all mounted along the top edge of the main PCB circuit board.

Terminals 1 to 22 are the smaller terminals (1.5 mm² cable) and are used for the sensors, inter-locking devices, remote speed and on/off control. (Screened cable must be used)

Terminals 29 to 34 are the larger terminals (4 mm² cable) and are for the power connections for the fans, gas valve and power supply to the unit.

The terminals are of the rising clamp type protection.

All cabling should be kept to the top of the unit within the designated area. No cables should be placed or laid across the PCBs as they may cause damage.

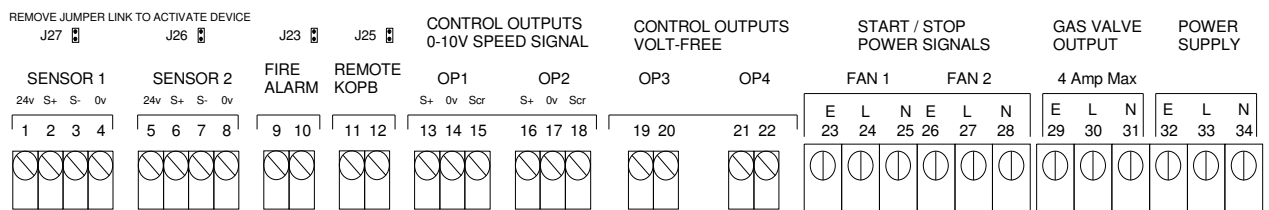

CaterSense the Intelligent answer

1.05 System mode and set-up

The CaterSense unit is a number of intelligent control solutions in one controller. Each of the solution types has a "Mode Code" which is set via a DIL switch mounted on the main PCB circuit board. The CaterSense also has a unique "Self-set" system commissioning tool which makes for easy system commissioning.

These devices are located on the left hand side of the main PCB, under the side cover, as detailed below.

Follow the instructions in the next section for your model of CaterSense.

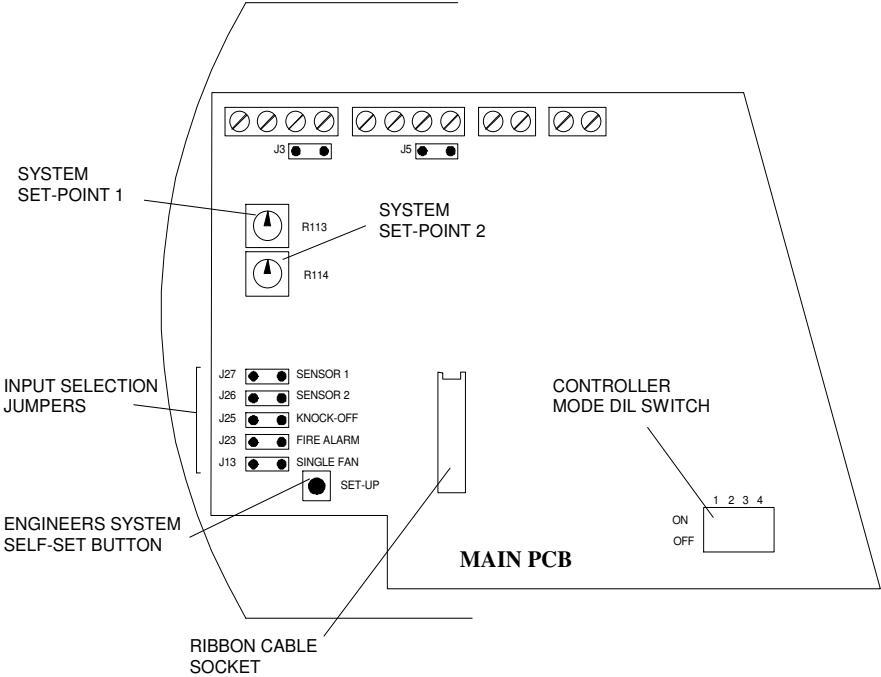

CaterSense *the Intelligent answer*

2.0 Set-up and Commissioning

The set-up and commissioning of your CaterSense system is in two parts, **Initial** and **Mode**.

2.01 Initial Set-up

Once all of the wiring has been completed and tested and the system is ready to be set-up and commissioned, the following sequence **MUST** be followed to ensure the CaterSense and system operate correctly.

- a) **DIL Mode switch**, Ensure the correct system code has been selected on the DIL switch. This code is detailed on the System Mode page for your installation.
- b) **Input Jumpers**, Ensure that the correct input jumpers have been removed as detailed on the System Mode page for your installation and jumper J13 is fitted if a single fan is being used.
- c) **Sensor Links**, If you are using four wire sensors in place of three wire type, remove Link **J3 & J5** as detailed on the System Mode page for your installation.
- d) Ensure that fire alarm and knock-off switches (if fitted) are all in the operational position.
- e) Refit the CaterSense facia plate by plugging in the ribbon cable and fixing the four screws.
NOTE: Ensure the ribbon cable is plugged in correctly with the key pin at the top (*see: ribbon diagram for further information*).

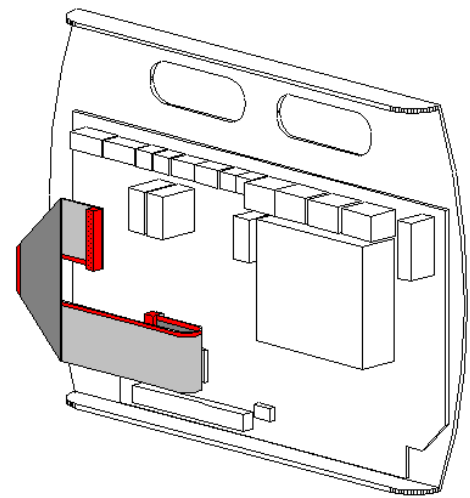

CaterSense the Intelligent answer





2.02 Mode Set-up – CaterSense 4

Once the above has been carried out, the system is now ready to be powered up.

The CaterSense unit is an intelligent unit with a self-set system and multi function LED indication. Within the next sequence of set-up instructions the CaterSense unit will give you feedback on the system and set-up via audible “beeps” and colour change / constant and flashing LEDs in a step by step sequence.

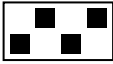
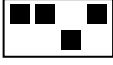
CaterSense 4

CaterSense 4 is a multi function controller with seven (7) pre-programmed controller models in one unit. These seven controllers are selected via the **DIL Mode** switch via a dedicated **Mode Code**.

Mode Code	DIL mode	Description
04-01		SINGLE EXTRACT CANOPY with FAN START / STOP - FPM (Optional SUPPLY FAN)
04-02		SINGLE EXTRACT CANOPY with FAN START / STOP - FPM (Optional SUPPLY FAN) and GAS PRESSURE PROVING
04-03		FOR FUTURE USE
04-04		GAS PRESSURE PROVING with PILOT VALVE (stand alone)
04-05		SINGLE EXTRACT CANOPY with FAN START / STOP - FPM (Optional SUPPLY FAN) and GAS PRESSURE PROVING with PILOT VALVE
04-06		REMOTE FAN CONTROL / AIR FLOW MONITORING STATION with GAS VALVE INTERLOCK
04-07		SINGLE EXTRACT FAN CANOPY - GAS PRESSURE PROVING with TEMPERED SUPPLY AIR CONTROL & FPM (Optional SUPPLY FAN)





CaterSense the Intelligent answer

CaterSense – 04 Single Extract Fan Canopy with Fan Power Monitoring (Optional Supply Fan)





Mode Code 04-01 Set-up and commissioning

Self-Set sequence





The sequence detailed below MUST be followed to enable the CaterSense unit to program its parameters. During the balancing phase of the set-up (1 & 2), ensure that the system is allowed to settle and become stable before moving on to the next stage. DO NOT RUSH.

- 1) PRESS   SYSTEM CONDITION
 (Hold for 3 secs)  GAS VALVE
 FAN 1, FAN 2
 All other LEDs

Ensure the fans are running at the speed at which they draw least current. THIS IS NOT NECESSARILY THE LOWEST SPEED. IMPORTANT – allow system to run and settle.

- 2) PRESS   SYSTEM CONDITION
 GAS VALVE
 FAN 1, FAN 2
 All other LEDs

The system will produce a short beep. Change the speed of the fans to the speed at which they draw maximum current. THIS IS NOT NECESSARILY THE HIGHEST SPEED. IMPORTANT – allow system to run and settle.

- 3) PRESS   GAS VALVE
 FAN 1, FAN 2
 All other LEDs

The system will stop the fans. The set-up is now complete and the system is ready to run.

Note: Please refer to section 2.03 (System Checking) before starting the CaterSense unit to ensure that it has been successfully commissioned.

Functional Operation

The operation of the CaterSense unit and system in this Mode is as follows:

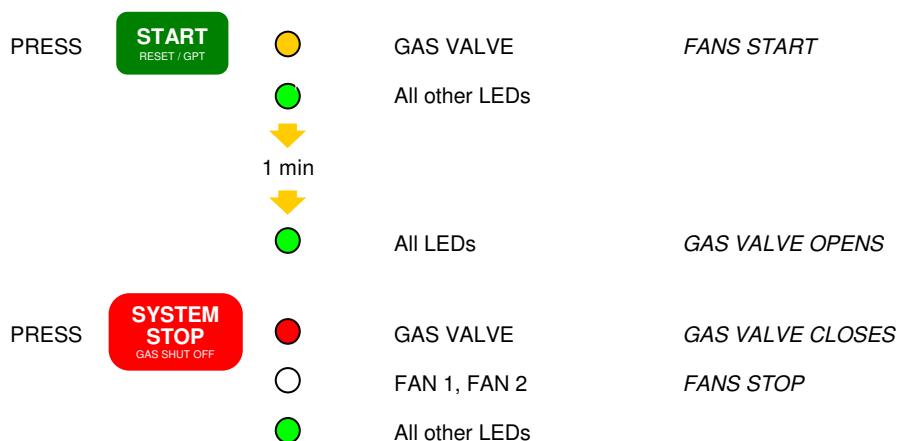

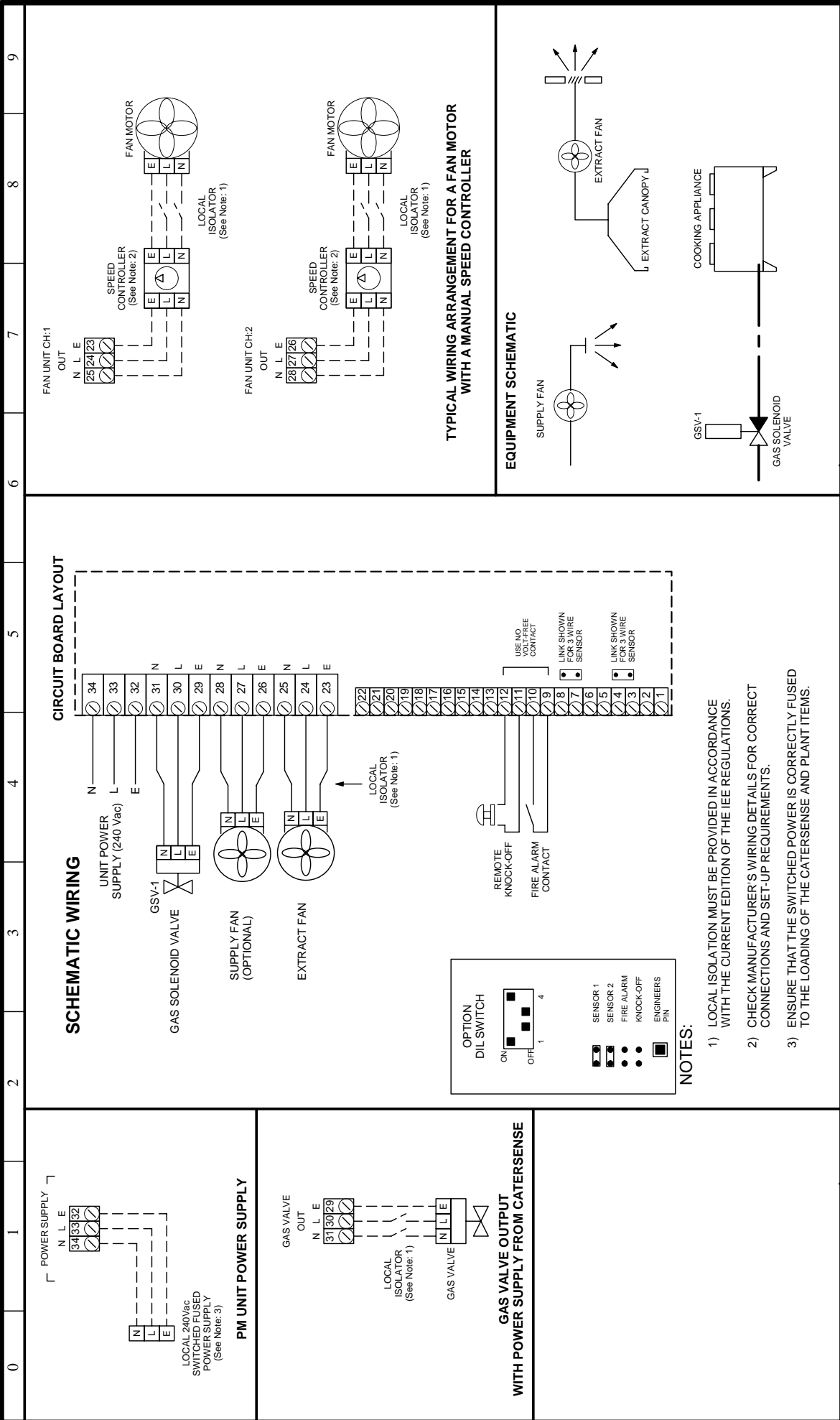

IF IN DOUBT, ASK

DATE:

DRAWING No:

DRAWN BY

NOTES:

- 1) LOCAL ISOLATION MUST BE PROVIDED IN ACCORDANCE WITH THE CURRENT EDITION OF THE IEE REGULATIONS.
- 2) CHECK MANUFACTURER'S WIRING DETAILS FOR CORRECT CONNECTIONS AND SET-UP REQUIREMENTS.
- 3) ENSURE THAT THE SWITCHED POWER IS CORRECTLY FUSED TO THE LOADING OF THE CATERSENSE AND PLANT ITEMS.

CATERSENSE -4 (04-01)

WIRING & CONNECTION DIAGRAM

05/01/06

CATERSENSE - 4

WD-04-01

MAE

CaterSense the Intelligent answer

CaterSense – 04





Single Extract Fan Canopy with Fan Power Monitoring and Gas Pressure Proving (Optional Supply Fan)

Mode Code 04-02

Set-up and commissioning













Self-Set sequence

The sequence detailed below MUST be followed to enable the CaterSense unit to program its parameters. During the balancing phase of the set-up (4 & 5), ensure that the system is allowed to settle and become stable before moving on to the next stage. DO NOT RUSH.





- 1) PRESS   SYSTEM CONDITION
 (Hold for 3 secs)  GAS VALVE
 FAN 1, FAN 2
 All other LEDs

- 2) PRESS   GAS VALVE

The gas valve will open for a maximum of 5 minutes to allow for system checking.





- 3) PRESS   GAS VALVE

 10 sec

 GAS VALVE

 30 sec

 SYSTEM CONDITION
- 4) PRESS   SYSTEM CONDITION
 GAS VALVE
 FAN 1, FAN 2
 All other LEDs

Ensure the fans are running at the speed at which they draw least current. THIS IS NOT NECESSARILY THE LOWEST SPEED. IMPORTANT – allow system to run and settle.

- 5) PRESS   SYSTEM CONDITION
 GAS VALVE
 FAN 1, FAN 2
 All other LEDs

CaterSense the Intelligent answer

The system will produce a short beep. Change the speed of the fans to the speed at which they draw maximum current. THIS IS NOT NECESSARILY THE HIGHEST SPEED. IMPORTANT – allow system to run and settle.

- 6) PRESS   GAS VALVE
 FAN 1, FAN 2
 All other LEDs

The system will stop the fans. The set-up is now complete and the system is ready to run.

Note: Please refer to section 2.03 (System Checking) before starting the CaterSense unit to ensure that it has been successfully commissioned.

Functional Operation

The operation of the CaterSense unit and system in this Mode is as follows:

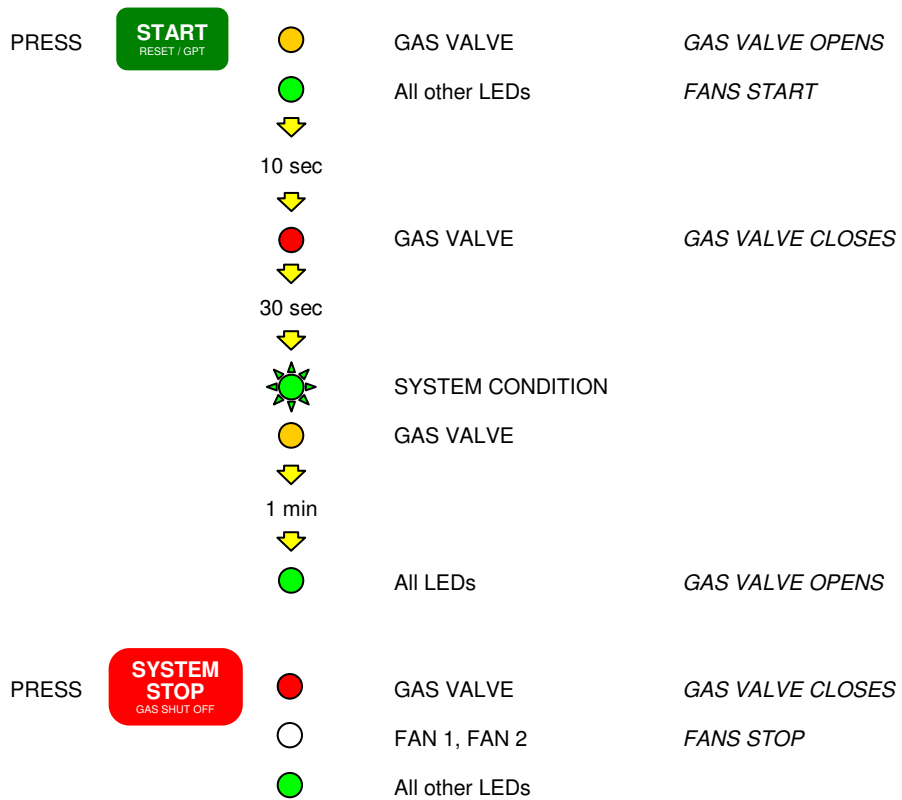

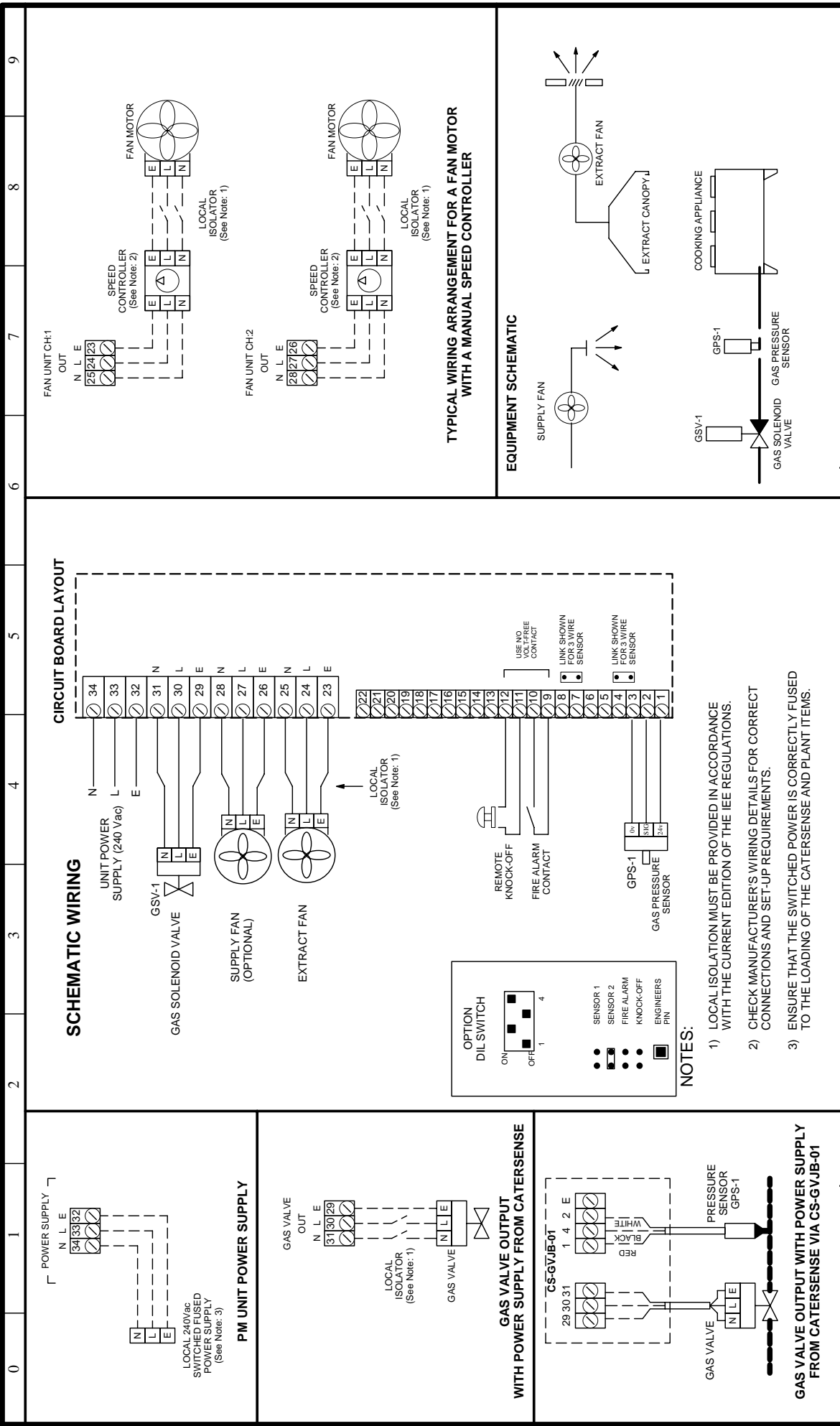

<p>TRENT PRODUCTS</p> <p>Tel: 01782 - 844688 Fax: 01782 - 844772</p>	<p>IF IN DOUBT, ASK</p>	<p>DATE:</p> <p>05/01/06</p>	<p>DRAWING No:</p> <p>CATERSENSE - 4 WD-04-02</p>	<p>DRAWN BY</p> <p>MAE</p>
---	--------------------------------	-------------------------------------	--	-----------------------------------

CaterSense the Intelligent answer

CaterSense – 04





Gas Pressure Proving System with Pilot Valve

Mode Code 04-04

Set-up and commissioning









Self-Set sequence

The sequence detailed below MUST be followed to enable the CaterSense unit to program its parameters.





- 1) PRESS   SYSTEM CONDITION
(Hold for 3 secs)  GAS VALVE
 FAN 1, FAN 2
 All other LEDs

- 2) PRESS   GAS VALVE

The main gas valve will open for a maximum of 5 minutes to allow for system checking.

- 3) PRESS   GAS VALVE

10 sec

 GAS VALVE

30 sec

 SYSTEM CONDITION

During the gas pressure proving test sequence, only the pilot valve will operate.

- 4) PRESS   GAS VALVE
 FAN 1, FAN 2
 All other LEDs

The set-up is now complete and the system is ready to run.

Note: Please refer to section 2.03 (System Checking) before starting the CaterSense unit to ensure that it has been successfully commissioned.

CaterSense the Intelligent answer

Functional Operation

The operation of the CaterSense unit and system in this Mode is as follows:

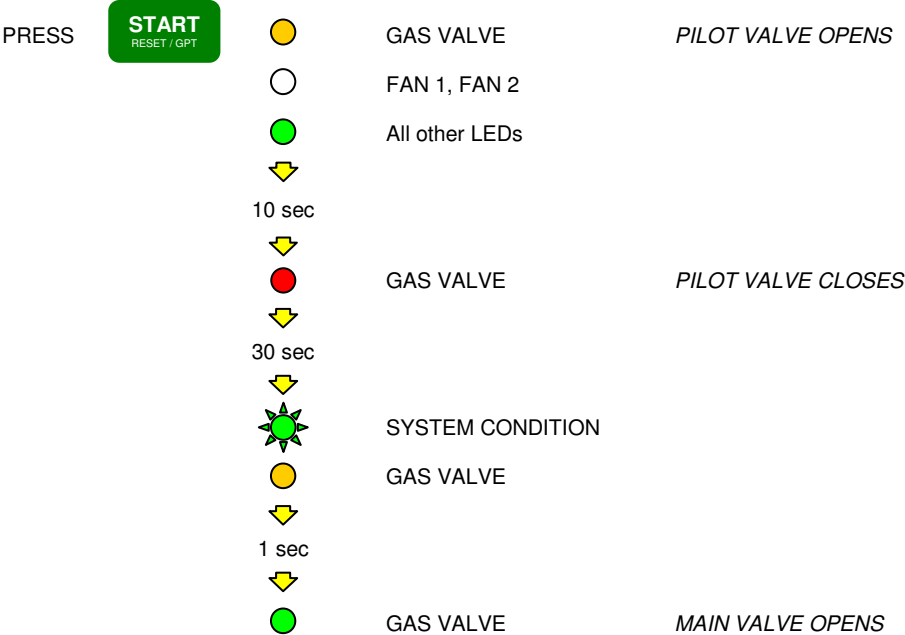

During the gas pressure proving test, only the pilot valve will operate. The main gas valve will open at the end of a successful gas pressure proving test.

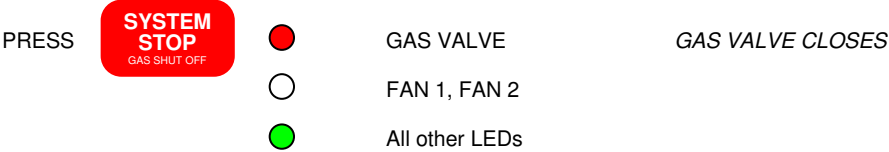

The gas valve will close.

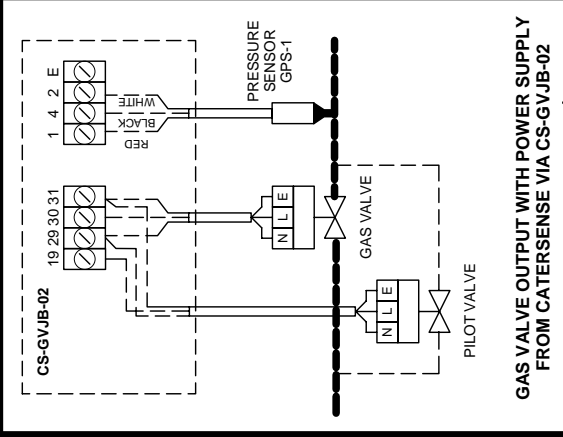
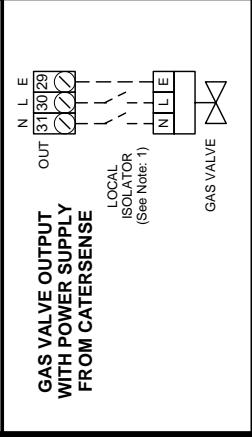
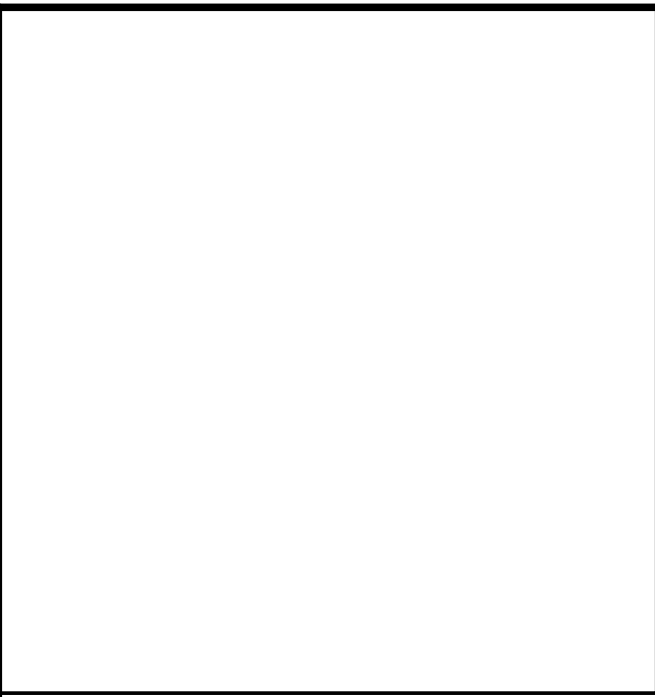
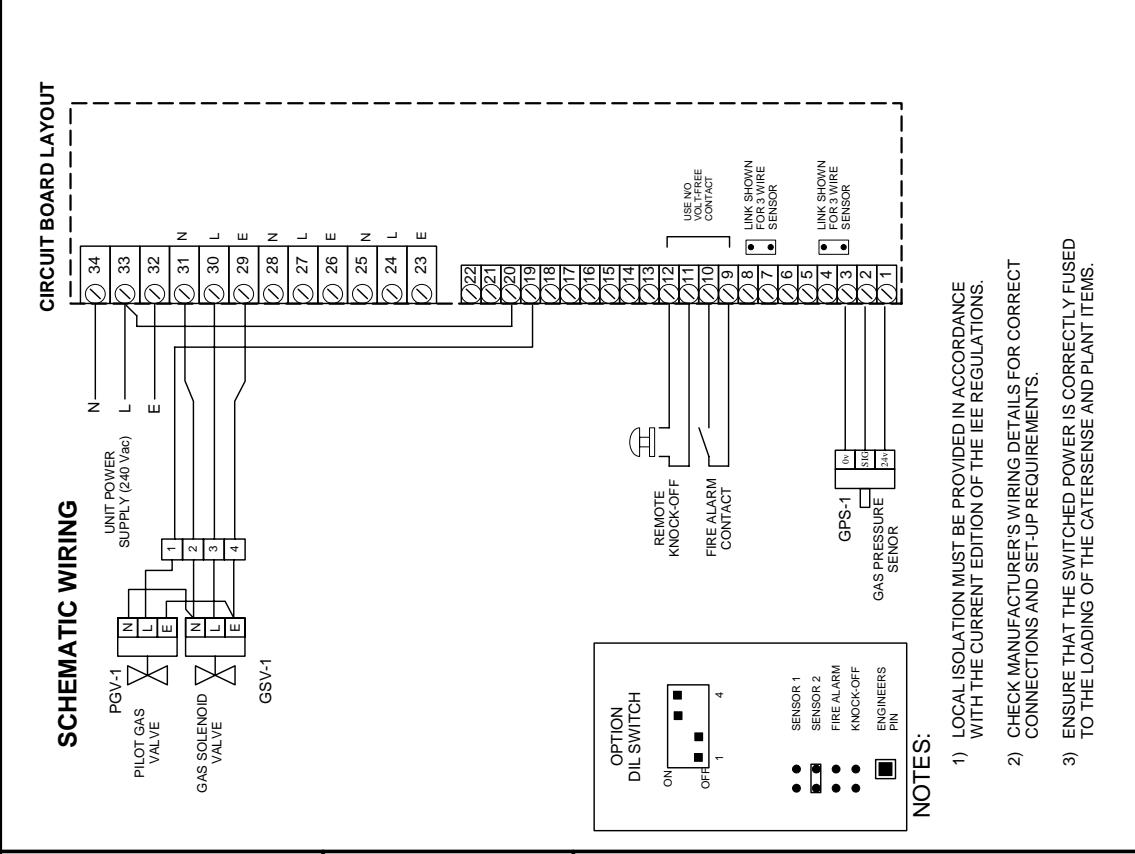
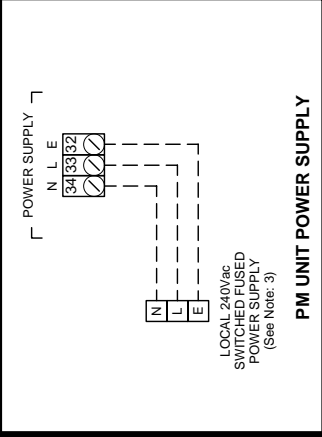

- NOTES:**
- 1) LOCAL ISOLATION MUST BE PROVIDED IN ACCORDANCE WITH THE CURRENT EDITION OF THE IEE REGULATIONS.
 - 2) CHECK MANUFACTURER'S WIRING DETAILS FOR CORRECT CONNECTIONS AND SET-UP REQUIREMENTS.
 - 3) ENSURE THAT THE SWITCHED POWER IS CORRECTLY FUSED TO THE LOADING OF THE CATERSENSE AND PLANT ITEMS.

<p>TRENT PRODUCTS</p> <p>Tel: 01782 - 844688 Fax: 01782 - 844772</p>	<p>IF IN DOUBT, ASK</p> <p>CATERSENSE -4 (04-04) WIRING & CONNECTION DIAGRAM</p>	<p>DATE:</p> <p>05/01/06</p>	<p>DRAWING No:</p> <p>CATERSENSE - 4 WD-04-04</p>	<p>DRAWN BY</p> <p>MAE</p>
---	---	-------------------------------------	--	-----------------------------------

CaterSense the Intelligent answer

CaterSense – 04







Single Extract Fan Canopy with Fan Power Monitoring and Gas Pressure Proving with Pilot Valve (Optional Supply Fan)

Mode Code 04-05









Set-up and commissioning

Self-Set sequence





The sequence detailed below MUST be followed to enable the CaterSense unit to program its parameters. During the balancing phase of the set-up (4 & 5), ensure that the system is allowed to settle and become stable before moving on to the next stage. DO NOT RUSH.

- 1) PRESS   SYSTEM CONDITION
(Hold for 3 secs)  GAS VALVE
 FAN 1, FAN 2
 All other LEDs
- 2) PRESS   GAS VALVE

The main gas valve will open for a maximum of 5 minutes to allow for system checking.





- 3) PRESS   GAS VALVE

10 sec

 GAS VALVE

30 sec

 SYSTEM CONDITION

During the gas pressure proving test sequence, only the pilot valve will operate.





- 4) PRESS   SYSTEM CONDITION
 GAS VALVE
 FAN 1, FAN 2
 All other LEDs

Ensure the fans are running at the speed at which they draw least current. THIS IS NOT NECESSARILY THE LOWEST SPEED. IMPORTANT – allow system to run and settle.

CaterSense the Intelligent answer

- 5) PRESS   SYSTEM CONDITION
 GAS VALVE
 FAN 1, FAN 2
 All other LEDs

The system will produce a short beep. Change the speed of the fans to the speed at which they draw maximum current. THIS IS NOT NECESSARILY THE HIGHEST SPEED. IMPORTANT – allow system to run and settle.

- 6) PRESS   GAS VALVE
 FAN 1, FAN 2
 All other LEDs

The system will stop the fans. The set-up is now complete and the system is ready to run.

Note: Please refer to section 2.03 (System Checking) before starting the CaterSense unit to ensure that it has been successfully commissioned.

Functional Operation

The operation of the CaterSense unit and system in this Mode is as follows:

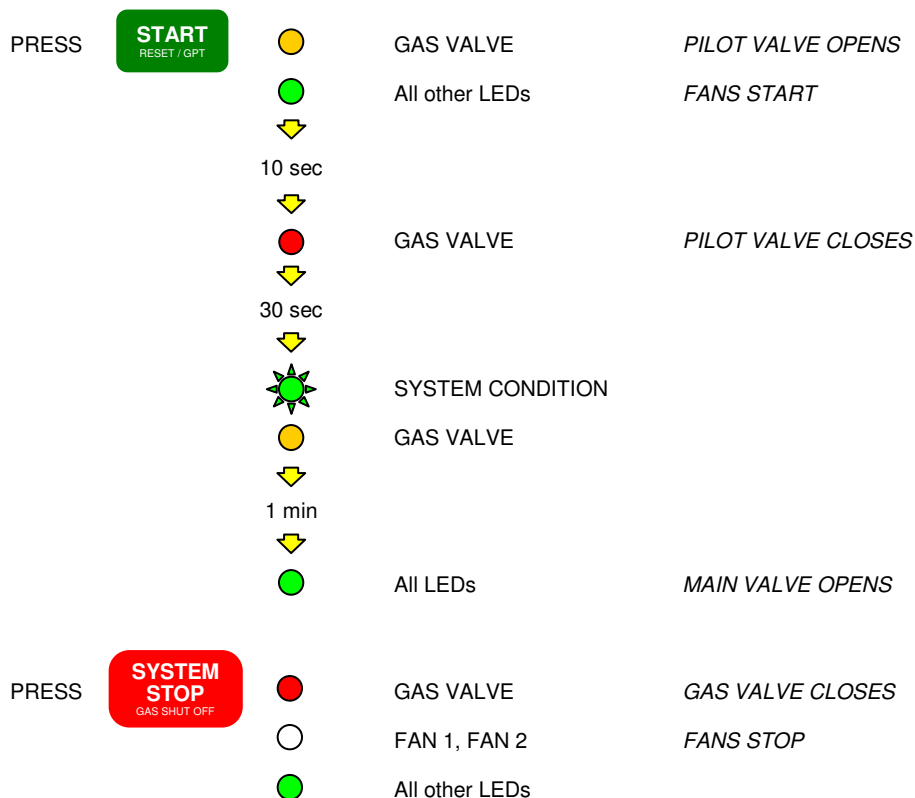





CaterSense the Intelligent answer

CaterSense – 04 Remote fan control / air flow monitoring station with gas valve interlock





Mode Code 04-06 Set-up and commissioning

Self-Set sequence

The sequence detailed below MUST be followed to enable the CaterSense unit to program its parameters. During the balancing phase of the set-up (1), ensure that the system is allowed to settle and become stable before moving on to the next stage. DO NOT RUSH.

- 1) PRESS   SYSTEM CONDITION
 (Hold for 3 secs)  GAS VALVE
 FAN 1, FAN 2
 All other LEDs

Ensure the fan is running at the speed which provides minimum design air flow rate. IMPORTANT – allow system to run and settle.





- 2) PRESS   GAS VALVE
 FAN 1, FAN 2
 All other LEDs

The set-up is now complete and the system is ready to run.

Note: Please refer to section 2.03 (System Checking) before starting the CaterSense unit to ensure that it has been successfully commissioned.

Functional Operation





The operation of the CaterSense unit and system in this Mode is as follows:

- PRESS   GAS VALVE *REMOTE FAN START*
 All other LEDs
 30 sec
 All LEDs *GAS VALVE OPENS*

During operation, the system constantly monitors the airflow sensor, and displays the status with the "FAN 1" LED.

-  Airflow HEALTHY
 Airflow LOW
 Airflow CRITICAL

If the airflow falls to the "CRITICAL" level for more than 30s or the remote control panel sends a "FAULT" signal, the system will alarm and the gas valve will close.

- PRESS   GAS VALVE *GAS VALVE CLOSES*
 FAN 1, FAN 2 *REMOTE FAN STOPS*
 All other LEDs

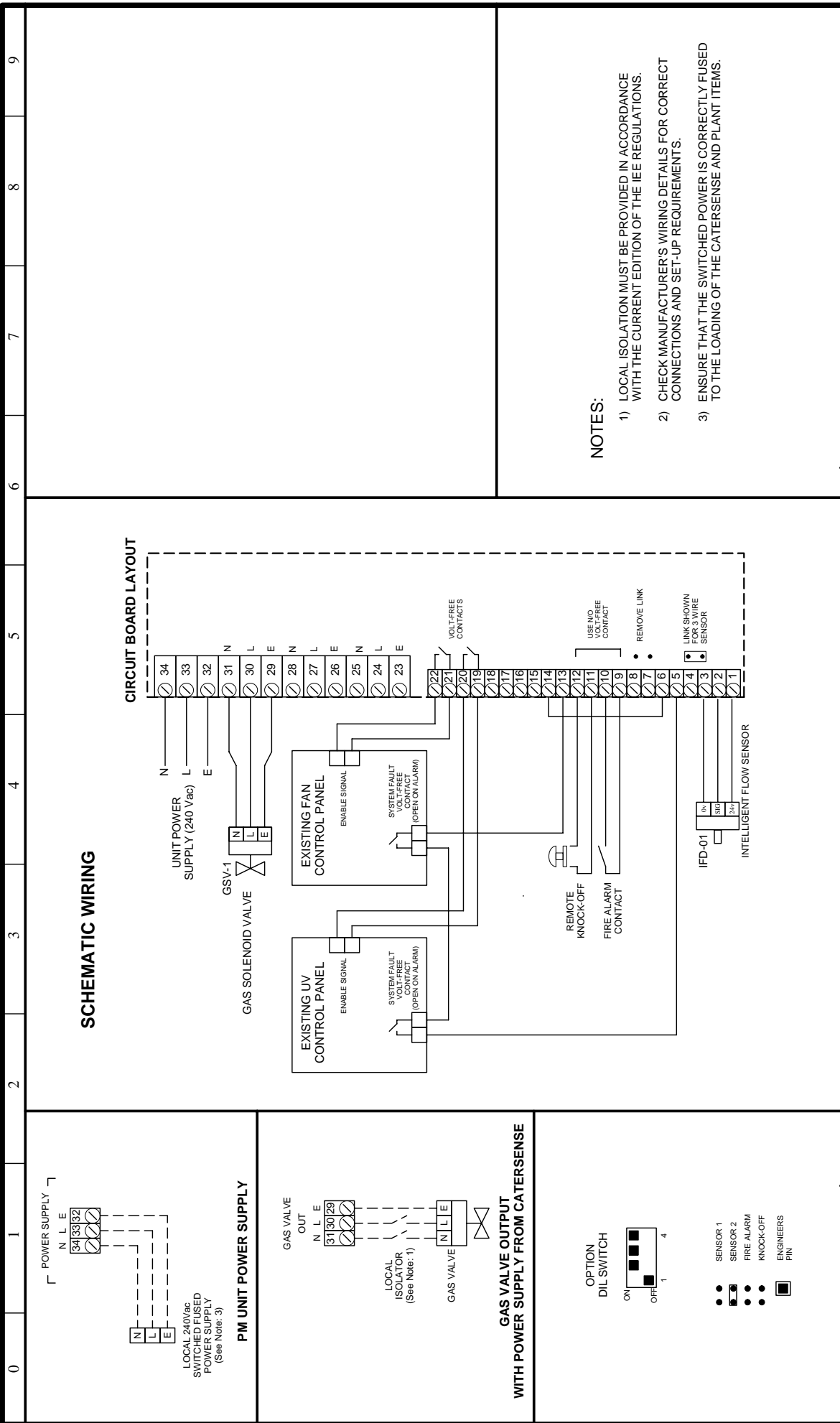

DRAWING No:	CATERSENSE - 4 WD-04-06	DRAWN BY	RR
DATE:	12/12/06	IF IN DOUBT, ASK	CATERSENSE -4 (04-06) WIRING & CONNECTION DIAGRAM
<p>TRENT PRODUCTS</p> <p>Tel: 01782 - 844688 Fax: 01782 - 844772</p>			





CaterSense the Intelligent answer

CaterSense – 04 Single Extract Fan Canopy with Fan Power Monitoring, Gas Pressure Proving, and Tempered Supply Air Control

Mode Code 04-07 Set-up and commissioning











Self-Set sequence

The sequence detailed below MUST be followed to enable the CaterSense unit to program its parameters. During the balancing phase of the set-up (4 & 5), ensure that the system is allowed to settle and become stable before moving on to the next stage. DO NOT RUSH.





- 1) PRESS   SYSTEM CONDITION
(Hold for 3 secs)  GAS VALVE
 FAN 1, FAN 2
 All other LEDs

- 2) PRESS   GAS VALVE

The gas valve will open for a maximum of 5 minutes to allow for system checking.





- 3) PRESS   GAS VALVE
 10 sec
 GAS VALVE
 30 sec
 SYSTEM CONDITION
- 4) PRESS   SYSTEM CONDITION
 GAS VALVE
 FAN 1, FAN 2
 All other LEDs

Ensure the fans are running at the speed at which they draw least current. THIS IS NOT NECESSARILY THE LOWEST SPEED. IMPORTANT – allow system to run and settle.

- 5) PRESS   SYSTEM CONDITION
 GAS VALVE
 FAN 1, FAN 2
 All other LEDs

CaterSense *the Intelligent answer*

The system will produce a short beep. Change the speed of the fans to the speed at which they draw maximum current. THIS IS NOT NECESSARILY THE HIGHEST SPEED. IMPORTANT – allow system to run and settle.

- 6) PRESS   GAS VALVE
 FAN 1
 FAN 2
 All other LEDs

The system will stop fan 1. Fan 2 has a built in run-on timer for heat dissipation, so this will run for 15 minutes. The setpoint for the tempered air control can be adjusted from 18°C ± 3°C using pot R114 on the main PCB.

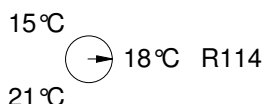

The set-up is now complete and the system is ready to run.

Note: Please refer to section 2.03 (System Checking) before starting the CaterSense unit to ensure that it has been successfully commissioned.

Functional Operation

The operation of the CaterSense unit and system in this Mode is as follows:

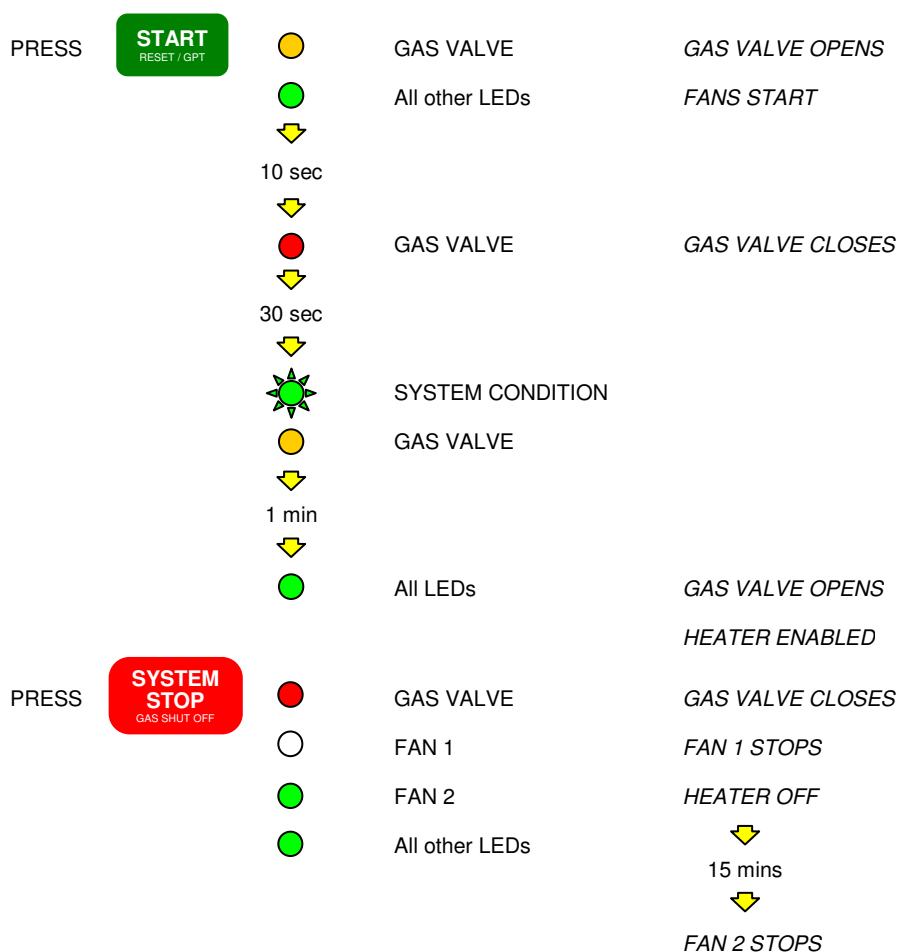

A modulating signal will be sent to the heater battery to maintain the temperature of the supply air above the setpoint selected during set-up.

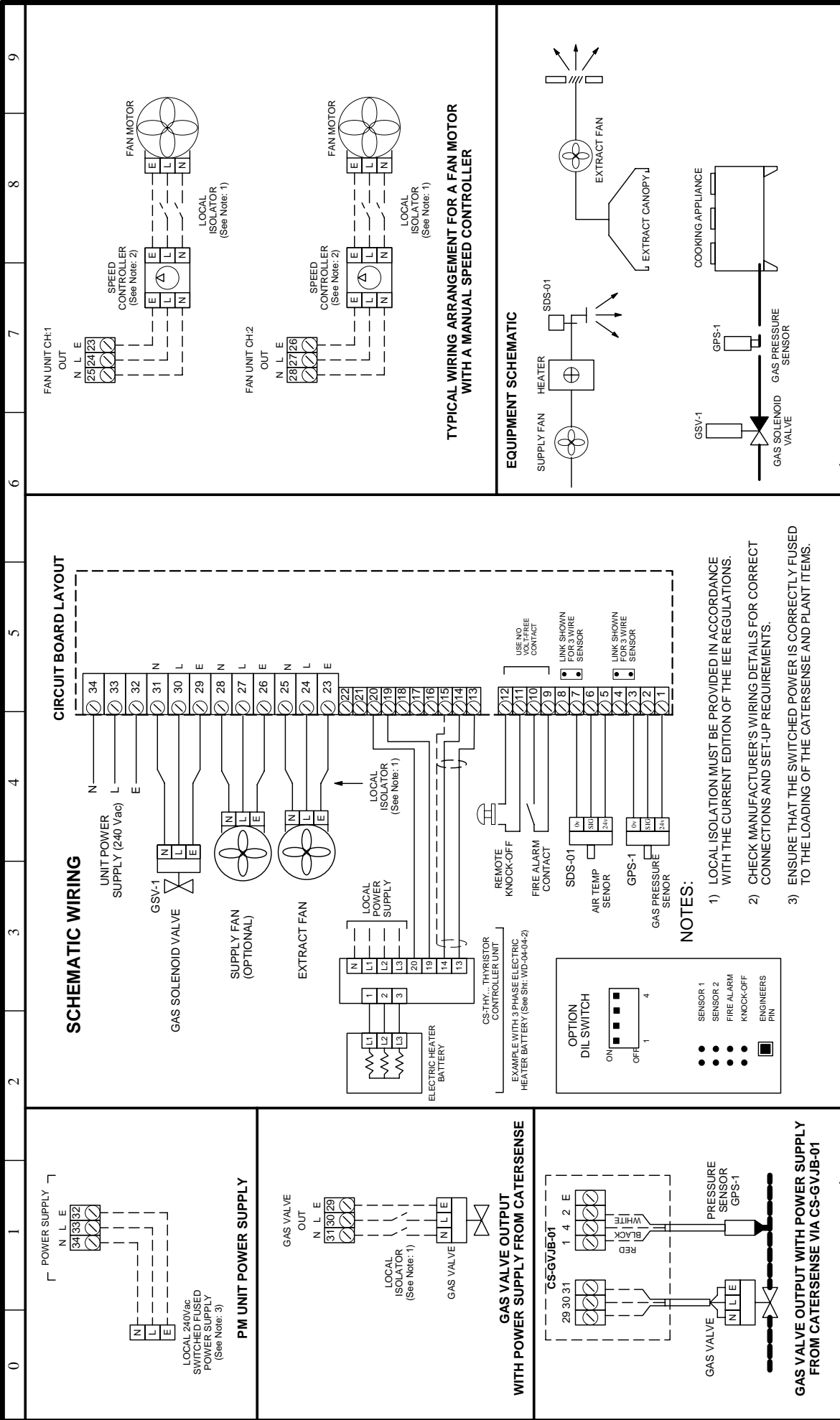

<p>IF IN DOUBT, ASK</p>	<p>DATE:</p> <p>05/01/06</p>	<p>DRAWING No:</p> <p>CATERSENSE - 4 WD-04-07</p>	<p>DRAWN BY</p> <p>MAE</p>
<p>CATERSENSE - 4 (04-07)</p> <p>WIRING & CONNECTION DIAGRAM</p>		<p>TRENT PRODUCTS</p> <p>Tel: 01782 - 844688 Fax: 01782 - 844772</p>	

SCHEMATIC WIRING

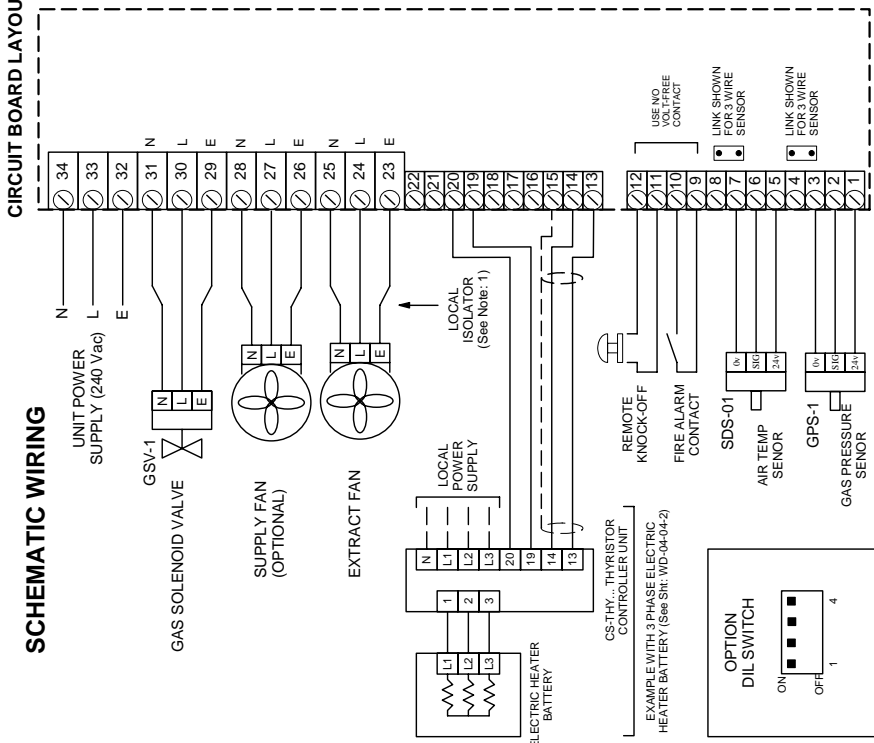

NOTES:

- 1) LOCAL ISOLATION MUST BE PROVIDED IN ACCORDANCE WITH THE CURRENT EDITION OF THE IEE REGULATIONS.
- 2) CHECK MANUFACTURER'S WIRING DETAILS FOR CORRECT CONNECTIONS AND SET-UP REQUIREMENTS.
- 3) ENSURE THAT THE SWITCHED POWER IS CORRECTLY FUSED TO THE LOADING OF THE CATERSENSE AND PLANT ITEMS.

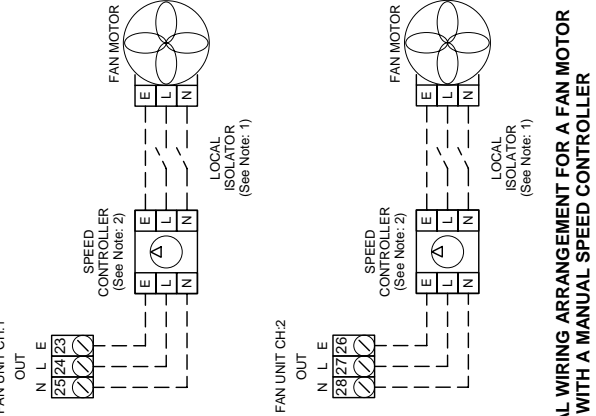

TYPICAL WIRING ARRANGEMENT FOR A FAN MOTOR WITH A MANUAL SPEED CONTROLLER

EQUIPMENT SCHEMATIC

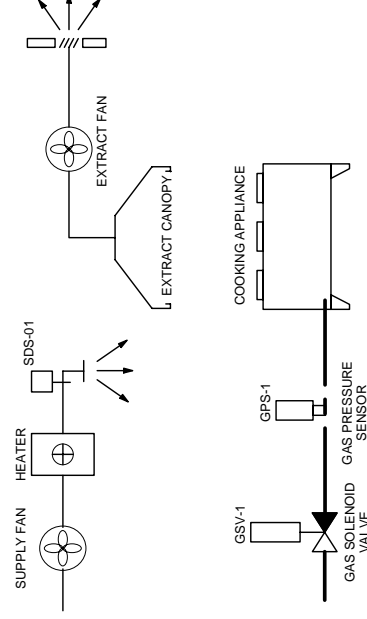

CaterSense the Intelligent answer

2.03 System Checking

As an aid to system commissioning, CaterSense has a diagnostic tool which can be used to quickly check that the stored settings are suitable for correct operation.

To access this tool,

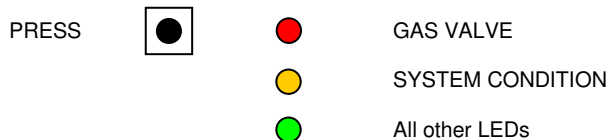

In this mode, the FAN 1 and FAN 2 LEDs will instantly react to the current being drawn by the attached motors. By slowly adjusting the speed control for the motors and observing the LEDs, the parameters can be quickly checked and problems identified.

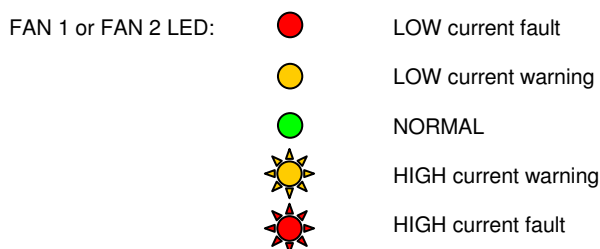

If the current is at a "fault" level for longer than 30s, a system fault would occur during normal operation. It is normal for current draw to fall outside normal levels for a few seconds whilst changing speeds. Allow fan to settle at each speed. IF IN DOUBT, ASK.

Diagnostic mode also allows the manual opening of the gas valve for testing purposes, for a maximum of 5 minutes.

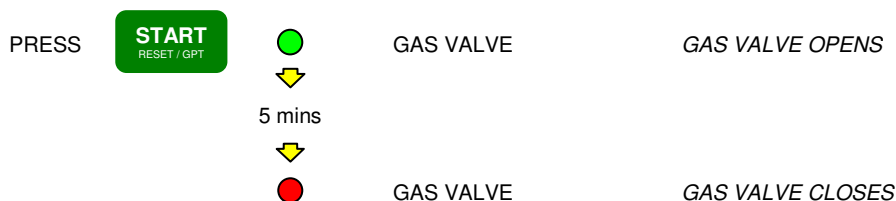







To leave diagnostic mode, press









2.04 Troubleshooting

2.04.1 - SYSTEM STOPPED

 POWER ON	 GAS VALVE
 SYSTEM CONDITION	
 REMOTE KNOCK OFF	 FAN 1
 FIRE ALARM	 FAN 2







Cause: - The system has been stopped
Solution: - Press "Start" key to begin startup sequence

2.04.2 - FIRE ALARM

 POWER ON	 GAS VALVE
 SYSTEM CONDITION	
 REMOTE KNOCK OFF	 FAN 1
 FIRE ALARM	 FAN 2







Cause: - The link between terminals 9 and 10 has been broken (fire alarm activated). The fan and gas valve outputs will be deactivated.
Solution: - Ensure fire alarm is not activated. Check wiring to fire alarm Interface panel. The system must be reset by pressing "STOP" before it can be restarted.

2.04.3 - KNOCK OFF BUTTON

 POWER ON	 GAS VALVE
 SYSTEM CONDITION	
 REMOTE KNOCK OFF	 FAN 1
 FIRE ALARM	 FAN 2

Cause: - The link between terminals 11 and 12 has been broken (knock off pressed). The gas valve output will be deactivated.
Solution: - Ensure remote knock off button has been released. Check wiring to remote knock-off button. The system must be reset by pressing "STOP" before it can be restarted.

2.04.4 - FAN UNDERCURRENT

 POWER ON	 GAS VALVE
 SYSTEM CONDITION	
 REMOTE KNOCK OFF	 FAN 1 or FAN 2
 FIRE ALARM	

Cause: - The indicated fan is drawing less current than the minimum current established during commissioning.
Solution: - Ensure fan is working correctly. Check running current with an ammeter. Use the diagnosis mode to establish any problems with set-up. The system must be reset by pressing "STOP" before it can be restarted.







CaterSense the Intelligent answer

2.04.5 - FAN OVERCURRENT

	POWER ON		GAS VALVE
	SYSTEM CONDITION		
	REMOTE KNOCK OFF		FAN 1 or FAN 2
	FIRE ALARM		







Cause: - The indicated fan is drawing more current than the maximum current established during commissioning.
Solution: - Ensure fan is working correctly. Check running current with an ammeter. Check filters are clean. Use the diagnosis mode to establish any problems with set-up. The system must be reset by pressing "STOP" before it can be restarted.

2.04.6 - GAS PRESSURE FAULT 1

	POWER ON		GAS VALVE
	SYSTEM CONDITION		
	REMOTE KNOCK OFF		FAN 1
	FIRE ALARM		FAN 2







Cause: - The system has failed its initial gas pressure test.
Solution: - Ensure all gas appliances are off. Check wiring to gas pressure sensor. Check gas pressure. The system must be reset by pressing "STOP" before it can be restarted.

2.04.7 - GAS PRESSURE FAULT 2

	POWER ON		GAS VALVE
	SYSTEM CONDITION		
	REMOTE KNOCK OFF		FAN 1
	FIRE ALARM		FAN 2

Cause: - The gas pressure has dropped below 12mbar during normal running.
Solution: - See above.

2.04.8 - MEMORY ERROR

	POWER ON		GAS VALVE
	SYSTEM CONDITION		
	REMOTE KNOCK OFF		FAN 1
	FIRE ALARM		FAN 2

Cause: - The system has failed the test of its internal memory (tested at power on).
Solution: - The system must be recommissioned to store new values into the memory. Please contact a competent person and consult your installation manual.

If the above does not solve your problem, contact Trent Products.

** Only on modes with gas pressure proving*

CaterSense the Intelligent answer

FOR FURTHER TECHNICAL ASSISTANCE, PLEASE CONTACT US BY

Phone: 01782 844688

Fax: 01782 844772

E-mail: info@trentproducts.com

Web site: www.trentproducts.com

- Note:
- i) Ensure that the electrical installation has been installed in accordance with the current edition of the IEE regulations.
 - ii) Ensure that the gas installation has been installed in accordance with the current gas regulations and GAS SAFE guide-lines.
 - iii) Ensure that the ventilation and extract system has been set to the correct air flow design levels in accordance with the current regulations.
 - iv) If in doubt, ask! (contact us on or by any of the above).
 - v) Ensure that the client has been shown how to operate the system and that they have been handed the users guide.

TRENT PRODUCTS
Trent House
Dewsbury Road
Fenton
Stoke-on-Trent
Tel: 01782 844688 Fax: 01782 844772